



Precise surveying and measuring



LASERS AND ACCESSORIES
BUILDERS' LEVELS AND THEODOLITES
TRIPODS
MEASURING TOOLS
SURVEYING EQUIPMENT



CATALOGUE
2024 / 2025



NEDO: THE COMPANY

Measuring equipment made in Dornstetten

For more than 120 years the Nedo brand has stood for intelligent measuring equipment of outstanding quality, made in Dornstetten.

Surveying engineers and construction professionals in more than 100 countries rely on Nedo products every day to perform a wide range of measuring tasks. Professionals in the building trades value our products for their quality, reliability and sturdiness. Our sales partners appreciate our commitment to customers, on-time deliveries and excellent service.

We maintain long-term cooperation agreements with sales partners in Germany and abroad. Nedo products are sold via a global network of qualified distributors. Customers in North America are supplied via our logistics centre and sales office in Kentucky, USA.

Although we do business throughout the world, we are still an owner-managed family company with strong roots in Dornstetten and the Black Forest. For four generations, Nedo and its owners, the Fischer family, have stood for fairness, reliability and a focus on customers.



Dipl.- Wirtschafts-Ing. Frank Fischer
President

Dr. Ing. Thomas Fischer
President



Engineering expertise

The path from idea to production-ready product is often long and difficult. From the initial design to final testing by critical craftsmen and surveying engineers, our ten-member interdisciplinary development team has to solve a host of problems and work out creative solutions. Our engineers and developers apply in-depth knowledge and experience from areas such as mechanical engineering, electrical engineering, mechatronics, optics and optoelectronics.

In addition, we apply our broad-based manufacturing know-how to the development process, ensuring already in the development stage that our products can be manufactured economically and at a consistent level of quality.

We pay special attention to simple and intuitive handling, reliability under harsh site conditions and functional design. Our developers and engineers have won a number of prizes for excellent design, including the **Red Dot Design Award** and the **Baden-Württemberg International Design Prize**. They are proud of their achievements and determined to maintain these standards in the future.

We will gladly make our expertise available to customers who would like us to develop special products.



Manufacturing know-how

Nedo manufactures high-tech products at plants in Dornstetten and Switzerland. Its highly motivated employees receive continuous further training and use state-of-the-art technology.

Our corporate culture emphasises optimally structured production processes, efficient logistics and an uncompromising commitment to quality. By means of Nedo's continuous improvement process, our employees are constantly finding ways to optimize company operations.

Needless to say, Nedo's quality management system is certified to DIN EN ISO 9001:2015.



Instead of relocating our production to low-wage countries, we have made substantial investments in our plants in Germany and Switzerland, and we have continuously improved the competitiveness of our production locations through rigorous cost management. Thanks to our large vertical range of manufacture we are independent of suppliers to a high degree. Production processes which are critical to product quality are kept under the direct control of our employees rather than being outsourced to other companies.

For our customers this means highly reliable products, strict adherence to delivery deadlines and flexibility when it comes to fulfilling special requests.



Nedo's premises in Dornstetten
 Our premises in Dornstetten cover an area of more than 5 hectares. Seven buildings with a total of 16,000 m² are devoted to development, production, logistics and administration



Company building in Riedsteige 1913

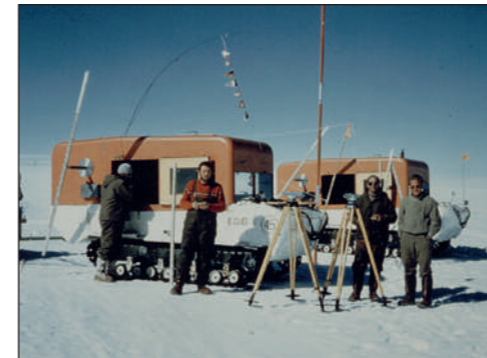

Nedo products in a polar expedition 1963



Nedo products in use at CERN



Nedo logistics center

Nedo milestones in Dornstetten

- 1901** The company is founded by Hermann Nestle
- 1938** Dipl.-Ing. Walter Alfred Fischer, son-in-law of the company's founder becomes a shareholder
- 1955** Start of production in Hochgerichtstraße
- 1962** Dipl.-Ing. Walter Hermann Fischer is appointed managing director
- 1977** Nedo launches production of wooden and aluminium tripods
- 1981** Dipl.-Ing. Walter and Gisela Fischer found FIMEX AG in Switzerland. Nedo adds measuring tools to its product line
- 1982** A revolutionary process for manufacturing high-precision scales goes into operation
- 1988** The first electronic levelling rod is presented
- 1996** Gisela Fischer is appointed as an additional managing director
- 1997** Certification of Quality Management System according to ISO 9001
- 2000** Dr.-Ing. T. Fischer and Dipl. Wirtschafts-Ing. F. Fischer are appointed as managing directors
- 2001** Nedo celebrates its 100th anniversary
- 2002** Nedo opens a US sales office and logistics center
- 2009** Nedo presents a new laser programme
- 2011** Nedo wins the Red Dot Design Award for its products PRIMUS 2 and QUASAR 6
- 2014** Nedo products are used at CERN
- 2018** Presentation of the innovative Flexijet 3D surveying system
- 2019** Presentation of the new TUBUS 2 Pipe Laser
- 2021** Nedo celebrates its 120th anniversary
- 2023** Opening of the new logistics center

160 employees – 1 goal: delighted customers

For Nedo, focusing on customers means listening to them. Only in this way we are able to find out wishes of our users and sales partners.

Nedo is committed to high delivery readiness, extremely short delivery times and quick, correct order processing. Flexibility in responding to special requests is an integral part of our company culture.

Our experienced in-house sales team and expert engineers, regional sales representatives and international distributors provide support to our sales partners in Germany and abroad and are always ready to help solve difficult problems involving measuring equipment in construction. Thanks to our logistics partners, we are able to ship Nedo products quickly and safely to destinations all around the world.

Our POS wall system gives our sales partners an attractive means of displaying our products.

For us, focusing on customers means being able to provide quick help without red tape if repairs are necessary.

All Nedo products can be repaired by us or by our trained and certified service partners. Our sales partners can download spare parts lists without trouble from our website.

Easily understandable operating instructions are available in all relevant languages, and spare parts can be supplied at any time.

When can we delight you?



CONTENTS

10

LASERS/ACCESSORIES

- 12 Line lasers at a glance
- 14 CUBE
- 16 X-Liner
- 26 Laser Accessories for Interior Finishing
- 27 Laser Accessories for Line lasers
- 28 Rotating lasers at a glance
- 30 LINUS
- 32 SIRIUS
- 38 PRIMUS
- 50 TUBUS 2
- 54 Laser receivers
- 58 Accessories
- 63 Flexi Rods
- 64 Laser mEssfix-S
- 65 Laser Calibration

66

BUILDERS' LEVELS/ THEODOLITES

- 70 Builders' Levels F-series
- 71 Builders' Levels X-series
- 72 Builders' Levels Z-series
- 73 Electronic Theodolite ET-5

74

TRIPODS

- 78 Aluminium Tripods
- 81 Elevating Tripods
- 85 Tripods for machine control applications
- 86 Fix-it
- 87 Carbon Line Tripod
- 88 Industrial Line Tripod
- 92 Wooden Tripods
- 94 Accessories

98

MEASURING TOOLS

- 100 mEssfix
- 105 Telemeter
- 106 mEsstronic 2
- 108 mEsstronic 0.1
- 109 laser mEssfix 50
- 110 Leica DISTO
- 112 Measuring Wheels
- 116 Winkelfix
- 117 Winkeltronic

120

SURVEYING EQUIPMENT

- 122 Telescopic Levelling Staffs
- 126 Precision Invar Levelling Staffs
- 130 Circular Bubbles, Staff Levels and Folding Levelling Rules
- 131 LumiScale
- 132 EDM Accessories
- 134 Prism Poles
- 136 Prism Pole Accessories
- 137 Adapters for Prisms
- 138 Ranging Poles
- 140 Ranging Pole Supports
- 141 Surveying Accessories



LASERS / ACCESSORIES

Developed by Specialists, Manufactured by Experts, Prized by Construction Professionals.

Nedo offers a unique range of innovative construction lasers. Nedo lasers are renowned for their simple, intuitive operation, extremely robust design for use under harsh conditions and high precision.

Red laser diodes have proved their worth over many years. However, construction lasers with green diodes are becoming increasingly popular. The human eye can see green laser beams up to four times better than red ones with the same power. Nedo lasers which are intended to be used without laser receivers such as innovative multi-line lasers for interior finishing and the new pipe laser Nedo TUBUS 2 feature advanced green laser diodes for best visibility. Rotating lasers with red laser diodes in combination with laser receivers are still the first choice for all outdoor applications especially if a large working range is needed.

With their ingenious functions and intelligent range of accessories, Nedo laser products are genuine system solutions that open the way to significantly increased productivity in the building trades.





Nedo Dot and Line Lasers at a Glance!

Product	CUBE	CUBE green	X-Liner 5P	X-Liner 2	X-Liner 360 2 green	X-Liner 3D green	X-Liner 6 green
Laser configuration							
Laser functionality	Multi-line laser	Multi-line laser	5-beam point laser	Cross line laser	Multi-line laser	Multi-line laser	Multi-line laser

Technical data:								
Laser class	2/635 nm	2/532 nm	2/635 nm	2/635 nm	2/532 nm	2/515 nm	2/515 nm	
Protection class	IP 54	IP 54	IP 54	IP 54	IP 54	IP 54	IP 54	
Self levelling range	± 4°	± 4°	± 4°	± 4°	± 3°	± 3°	± 3°	
Power supply	3 x 1,5 V type mignon/AAA	3 x 1,5 V type mignon/AAA	2 x 1,5 V type mignon/AA	3 x 1,5 V type mignon/AA	4 x 1,5 V type mignon/AA	Li-Ion battery pack 7,4 V 2600 mAh	Li-Ion battery pack 7,4 V 2600 mAh	
Laser receiver				optional	optional	optional	optional	

Applications:								
Dry lining	***	***	**	**	***	***	***	
Interior finishing	**	**	**	**	***	***	***	
Electrical installations	**	**	**	**	**	***	***	
Carpentry	**	**	*	**	***	***	***	
Sanitary installations	**	**	*	**	***	***	***	
Alignment of construction components	**	**		**	***	***	***	
Tiling	***	***		**	***	***	***	
Ceiling and steel construction	*	*		*	**	***	***	
Paintwork	***	***		***	***	**	**	
Installation of doors and windows	**	**		**	***	***	***	
Metre marking in interior work	**	**		*	***	***	***	
360° horizontal line					1 X 360°	1 X 360°	1 X 360°	

* limited ** good *** optimal

The self-levelling multi-line laser **CUBE** creates a laser cross and an additional vertical laser line at right angles to the laser cross. That makes Nedo **CUBE** perfect not only for fast and uncomplicated levelling and aligning, but also for marking off right angles. Thanks to the laser clamp supplied with it, Nedo **CUBE** can be fastened anywhere. The Nedo **CUBE** can be supplied with green laser diodes for maximum visibility or with red laser diodes.



Green laser lines for excellent visibility



Scope of delivery:
CUBE, laser clamp made of metal, incl. ball joint, batteries and carrying case

Ref.-No. 460 867 (green laser diodes)
 Ref.-No. 460 869 (red laser diodes)



Also available in a package of eight with a practical counter display!

Ref.-No. 460 866 (green laser diodes)
 Ref.-No. 460 868 (red laser diodes)

Nedo CUBE

Universal multi-line laser for the tool box. Small, handy for a wide range of applications such as levelling, alignment and marking off right angles. Optional with green or red laser diodes.

Features:

- Self-levelling multi-line laser for levelling, alignment and easy squaring jobs in interior work
- Generates one laser cross and an additional vertical 90° laser line
- Highly visible laser lines
- Reliable magnetic damping
- Tilt function
- 1/4" mounting thread
- Practical laser clamp made of metal, incl. ball joint
- Extremely small and handy
- Incl. carrying case and batteries

Perfect for levelling and aligning especially for applications such as:

- Dry lining and interior work
- Tiling
- Surfacing and steel constructions
- Electrical installations
- Paint jobs
- Sanitary installations

Nedo CUBE

Ref.-No.	460 867 (green laser diodes)
Ref.-No.	460 869 (red laser diodes)
Accuracy	± 0.5 mm/m
Self-levelling range	± 4°
Working range Ø	30 m
Laser	Laser class 2, 532 nm (green laser diodes) Laser class 2, 635 nm (red laser diodes)
Protection class	IP 54
Power supply	3 x 1.5 V (AAA)
Operation duration	approx. 6 h
Dimensions	65 mm x 65 mm x 68 mm
Weight	0.24 kg

Easy, single-button operation. Reliable, magnetically damped pendulum for precise results. The device selflevels automatically on inclines of up to 4° so that the laser points from the X-Liner 5P are always projected exactly vertically or horizontally.



The strong magnet on the universal adapter allows the X-Liner 5P to be easily attached to steel girders.



- ± 0.3 mm/m
- Ø 30 m
- Auto
- IP 54
- laser class 2 635 nm
- 5P



Nedo X-Liner 5P

Self-levelling 5-beam point laser which transmits three horizontal and two vertical laser points: to the front, left, right, up and down.

The laser points are arranged in an exact right angle to one another. The horizontal laser points are all at one height. Ideal for rapid horizontal levelling, vertical alignment, plumbing and for marking off right angles jobs.

Features:

- 5 highly visible laser points aligned exactly at right angles
- Reliable self-levelling operation
- Robust pendulum with magnetic damping
- Universal adapter with strong magnet, 1/4" and 5/8" mounting thread



Scope of delivery:
X-Liner 5P, universal adapter with 1/4" and 5/8" mounting thread and magnet, fixing straps, target board, batteries and carrying case
Ref.-No. 460 871

Perfect for levelling, aligning and marking 90° angles, especially for applications such as:

- Dry lining
- Electrical installations
- Carpentry
- Sanitary installations
- Alignment of construction components

Nedo X-Liner 5P

Ref.-No.	460 871
Accuracy	± 0.3 mm/m
Self-levelling range	± 4°
Working range Ø	approx. 30 m
Laser	Laser class 2, 635 nm
Protection class	IP 54
Power supply	2 x 1.5 V type mignon / AA
Operation duration	approx. 33 h
Connecting thread	1/4"

The clearly arranged key pad allows for easy handling and the reliable, magnetically damped pendulum ensures precise results at all times.
The device will automatically self-level at inclines of up to 4°.



Nedo X-Liner 2

Self-levelling cross line laser with one vertical and one horizontal line. The highly visible laser cross on the wall allows rapid and precise levelling and alignment. Thanks to the pulse function, the **X-Liner 2** can be used with the **ACCEPTOR Line** laser receiver even in adverse light conditions.

Features:

- Self-levelling cross line laser for levelling and alignment
- Highly visible horizontal and vertical laser line, can be activated separately
- Pulse function for use with the **ACCEPTOR Line** laser receiver
- Reliable magnetic damping
- Tilt function
- Universal adapter with strong magnet and 1/4" and 5/8" mounting thread



Scope of delivery:
X-Liner 2, universal adapter, ball joint adapter, fixing straps, batteries, target board and carrying case
Ref.-No. 460 870

Perfect for levelling and aligning especially for applications such as:

- Dry lining and interior work
- Tiling
- Surfacing and steel constructions
- Electrical installations
- Paint jobs
- Sanitary installations

Nedo X-Liner 2

Ref.-No.	460 870
Accuracy	± 0.3 mm/m
Self-levelling range	± 4°
Working range Ø	approx. 50 m without laser receiver approx. 100 m with laser receiver
Laser	Laser class 2, 635 nm
Protection class	IP 54
Power supply	3 x 1.5 V type mignon / AA
Operation duration	approx. 20 h
Connecting thread	1/4"



Optional accessory:
Laser receiver **ACCEPTOR Line**
with mm display.
See on page 27

The continuous horizontal 360° laser line makes levelling jobs very easy. In the compact housing the two vertical laser lines are arranged exactly at right angles to each other. Their line of intersection passes through the pivot point of the tripod and the plumb point, making it easy to position the laser over a known point and mark off right angles. The fine adjustment permits quick and exact alignment of the axes.



- 360°
- Auto
- ± 0.3 mm/m
- Ø 60 m
- IP 54
- laser class 2 532 nm
- Pulse Mode



Green laser lines for excellent visibility



Scope of delivery:
X-Liner 360 2 green, removable tribrach with fine adjustment, laser glasses, target board, batteries, adapter with 1/4" and 5/8" connection thread and carrying bag
Ref.-No. 460 875



Optional accessory:
 Laser receiver **ACCEPTOR X green**
 See on page 27

Nedo X-Liner 360 2 green

Green multi-line laser with horizontal 360° laser line and two vertical laser lines for levelling, aligning, plumbing and marking off right angles in interior work. The green laser lines are particularly easy to see. Thanks to its rugged tribrach, the laser can be set up over dry wall profiles for layout applications.

Features:

- Self-levelling multi-line laser for levelling, aligning, plumbing and marking off right angles
- Green laser lines for excellent visibility
- Horizontal 360° laser line
- A laser cross on each of two walls
- Laser cross on the ceiling and plumb point on the floor
- Puls mode for operation with optional laser receiver **ACCEPTOR X green**
- The vertical laser lines extend far beyond the intersection point
- Reliable self-levelling with magnetic damping
- Sturdy, compact housing, splashwater protected, IP 54 rated
- Axis alignment is simple because the vertical laser planes intersect on a line that passes through the pivot point of the tripod and the plumb point
- Removable tribrach with fine adjustment for quick and exact axis alignment
- 1/4" and 5/8" connection thread

Perfect for levelling, aligning and marking off right angles, especially for applications such as:

- Metre marking in interior work
- Surfacing
- Dry lining
- Installation of doors and windows
- Tiling
- Structural steel work

Nedo X-Liner 360 2 green

Ref.-No.	460 875
Accuracy	± 0.3 mm/m
Self-levelling range	± 3°
Working range Ø	approx. 60 m without receiver approx. 120 m with receiver
Laser	Laser class 2, 532 nm
Protection class	IP 54
Power supply	4 x 1.5 V type mignon / AA
Operation duration	approx. 8 h
Connecting thread	1/4" and 5/8"

Thanks to its multi-functional wall mount, the **X-Liner 3D green** can be mounted with a clamp on a ceiling profile, with magnets on steel girders or with a screw on a wall. It goes without saying that it can be used on the floor or on a tripod, because the support comes with a base as well as 5/8" and 1/4" connection threads.



Green laser lines for excellent visibility



Scope of delivery:
X-Liner 3D green, multifunctional wall mount, target board, laser glasses, rechargeable batteries, charger, extra battery box and transport case
Ref.-No. 460 876



Optional accessory:
 Laser receiver **ACCEPTOR X green**
 See on page 27

Nedo X-Liner 3D green

Green multi-line laser with three 360° laser lines.

The highly visible green 360° laser lines and robust self-levelling mechanism allow quick and easy levelling, aligning, plumbing and marking off right angles in interior work.

Power is supplied by a high-performance Li-ion battery.

Features:

- Self-levelling multi-line laser for levelling, aligning, plumbing and marking off right angles
- Green laser lines for excellent visibility
- Laser cross on 4 walls, floor and ceiling
- Green laser lines for maximum visibility
- Puls mode for operation with optional laser receiver **ACCEPTOR X green**
- Robust design for tough use on construction site
- Sturdy housing, splashwater protected, IP 54 rated
- Reliable self-levelling with magnetic damping
- 1/4" and 5/8" connection thread
- Li-ion battery pack, charger and extra battery box for 4 x AA 1.5 V batteries
- Height adjustable, multifunctional wall mount

Perfect for levelling, aligning and marking off right angles, especially for applications such as:

- Metre marking in interior work
- Dry lining
- Ceiling construction
- Tiling
- Installation of doors and windows
- Steel construction

Nedo X-Liner 3D green

Ref.-No.	460 876
Accuracy	± 0.3 mm/m
Self-levelling range	± 3°
Working range Ø	approx. 50 m without receiver approx. 120 m with receiver
Laser	laser class 2, 515 nm
Protection class	IP 54
Power supply	Li-ion rechargeable batteries 7,4 V, 2600 mAh or 4 x 1,5 V type AA
Operation duration	up to 25 h
Connecting thread	1/4" and 5/8"

Clever details:

Nedo X-Liner 6 has a fine adjustment for quick and easy axis alignment. The fine adjustment is integrated into the base of the housing, allowing it to be used even when removed from the tribrach, for example when mounted on a tripod.



Green multi-line laser with a horizontal 360° laser line, four vertical laser lines at 90° angles, plus a downward plumb beam



Scope of delivery **X-Liner 6 green**:
X-Liner 6 green, removable tripod with fine adjustment, laser glasses, target board, rechargeable batteries, charger, extra battery box and transport case
Ref.-No. 460 877

Nedo X-Liner 6 green

The highly visible green laser lines and robust self-levelling mechanism allow quick levelling, aligning, plumbing and marking off right angles in interior work. The symmetrical design, integrated fine adjustment and plumb beam ensure quick set up and alignment of the vertical laser lines. Thanks to its rugged tribrach, the laser can be set up over dry wall profiles for layout applications. Power is supplied by a high-performance Li-ion battery.

Features:

- Self-levelling multi-line laser for levelling, aligning, plumbing and marking off right angles
- Green laser lines for excellent visibility
- Laser cross on four walls, cross on the ceiling and plumb point on the floor
- Axis alignment is simple because the vertical laser planes intersect on a line that passes through the pivot point of the tripod and the plumb point.
- The fine adjustment is integrated into the base of the housing, allowing it to be used even when removed from the tribrach, for example when mounted on a tripod
- Pulse mode for use of the optional **Acceptor X green** laser receiver
- Rugged design for tough jobs on construction sites
- Sturdy housing, splashwater protected, IP 54 rated
- Reliable self-levelling mechanism with magnetic damping
- Removable tribrach
- Integrated fine adjustment, available even when removed from tribrach
- 5/8" connection thread on the laser and tripod
- Li-ion battery, charger and spare battery compartment
- Target board and carrying case included

Perfect for levelling, aligning and marking off right angles, especially for applications such as:

- Metre marking in interior work
- Dry lining
- Ceiling construction
- Tiling
- Installation of doors and windows
- Steel construction



Optional accessory:
 Laser receiver **ACCEPTOR X green**
 See on page 27

Nedo X-Liner 6 green

Ref.-No.	460 877
Accuracy	± 0.3 mm/m
Self-levelling range	± 3°
Working range Ø	approx. 50 m without receiver approx. 120 m with receiver
Laser	laser class 2, 515 nm, 1 mW
Protection class	IP 54
Power supply	Li-Ion rechargeable batteries 7,4 V, 2600 mAh or 4 x 1,5 V type AA
Operation duration	up to 25 h (depending on operating mode)
Connecting thread	5/8"

Laser adapter

For quick and easy attachment of line and rotating lasers to a monopod.

Ref.-No. 461 011



Tilting head

Tilting head for line lasers with 1/4" thread

Ref.-No. 062 148



Nedo Laser Accessories for Interior Finishing

Nedo Monopod

Sturdy monopod for holding line and rotating lasers, especially in tight spaces. The monopod is clamped between the floor and the ceiling. Suitable for rooms up to 3.40 m in height. Comes with a sturdy laser adapter that is fixed to the monopod at the required working height.

The laser adapter has a variety of attachment options:

Features:

- 1/4" clamping screw for line lasers
- 5/8" clamping screw for rotating lasers
- Easy mount for Simplix multi-functional support

Ref.-No. 460 995



Multifunctional Wall Mount

Features:

- Eyelet for fixing to a screw
- Strong magnets for fixing to steel girders
- Adjustable quick-locking system for easy fixing to ceiling sections and battens
- Rough and fine adjustment allows rapid height settings
- 1/4" and 5/8" thread for attachment to tripods

Ref.-No. 063 075



Nedo Magnet Adapter

Features:

- Strong magnets for fixing to steel girders
- 1/4" thread for attachment to tripods
- 5/8" thread for attachment to tripods

Ref.-No. 062 548



Laser receiver with mm display



Nedo Laser Accessories for Line Lasers

Laser Receiver ACCEPTOR Line with mm display for Nedo red line lasers with pulse mode

Features:

- Robust laser receiver for red line lasers with a wavelength of 610 – 780 nm
- Large detector field of 50 mm length
- Readout of height difference in mm
- Large illuminated LC displays on the front and back
- Größe der Richtungspfeile ist proportional zur Höhendifferenz
- Bright LED display
- 2 accuracy settings: ± 1 mm and ± 4 mm
- Working range: \varnothing 100 m
- Battery status shown in display
- Switchable acoustic signal
- Bubble for easy alignment
- Strong magnets for fixing to steel girders
- Automatic shut-off after 15 min.
- Protection class: IP 67
- Power supply 2 x 1,5V (AA)
- Operation duration: up to 70 h
- Batteries supplied as standard
- Available on request with quick clamp or Heavy-Duty rod clamp made of diecast aluminium



With quick clamp
Ref.-No. 430 336



With Heavy-Duty rod clamp
Ref.-No. 430 337

Laser Receiver ACCEPTOR X green

Features:

- Laser receiver for green line lasers with a wavelength of 510 – 540 nm
- Detector field of 20 mm length
- Displays on the front
- Bright LEDs at frontside, backside and left side
- Switchable acoustic signal
- Bubble for easy alignment
- Automatic shut-off after 10 min.
- Protection class: IP 54
- Power supply: 1 x 9 V battery
- Operation duration: up to 15 h
- Rod clamp and batteries supplied as standard



Ref.-No. 430 323

Magnetic Target Board Green

The target board is attached to the ceiling profiles with magnets. For green lasers.

Ref.-No. 460 908-613 (green)



Laser Glasses Red or Green

Improves the visibility of laser beams. For red and green lasers.

Ref.-No. 460 907-613 (red)
Ref.-No. 460 908-613 (green)



Nedo Universal and Rotating Lasers at a Glance!

Product	LINUS 1 HV	SIRIUS 1 H	SIRIUS 1 HV	SIRIUS 1 HV green	PRIMUS 2 H	PRIMUS 2 H1N+ Long Range	PRIMUS 2 H2N PRIMUS 2 H2N+	PRIMUS 2 HVA	PRIMUS 2 HVA2N
Laser configuration									
Laser functionality	Universal laser horizontal 360° laser line 4 laser lines at 90° angles	Rotating laser horizontal	Rotating laser horizontal/vertical	Rotating laser horizontal/vertical	Rotating laser horizontal	Rotating laser horizontal Single slope laser	Rotating laser horizontal Dual slope laser	Rotating laser horizontal/vertical with AutoAlign function	Rotating laser horizontal/vertical with AutoAlign function Dual slope laser
Technical data:									
Laser class	2M/635 nm	3R/635 nm or 2/635 nm	3R/635 nm or 2/635 nm	3R/532 nm or 2/515nm	3R/635 nm or 2/635 nm	3R/635 nm or 2/635 nm	3R/635 nm or 2/635 nm	3R/635 nm or 2/635 nm	3R/635 nm or 2/635 nm
Protection class	IP 65	IP 65	IP 65	IP 65	IP 66	IP 66	IP 66	IP 66	IP 66
Slope	-	-	manual, dual slope	manual, dual slope	-	direct entry, single slope	direct entry, dual slope	manual, dual slope	direct entry, dual slope
AutoAlign function	-	-	-	-	-	-	-	•	•
Self-levelling range	± 5° with autom. level control	± 5° with autom. level control	± 5° with autom. level control	± 5° with autom. level control	± 5° with automatic level control	± 5° with automatic level control	± 5° with automatic level control	± 5° with automatic level control	± 5° with automatic level control
Levelling accuracy (horizontal/vertical)	± 1 mm/10 m	± 1 mm/10 m	± 1 mm/10 m	± 1 mm/10 m	± 0.5 mm/10 m	± 0.5 mm/10 m	± 0.5 mm/10 m	± 0.5 mm/10 m	± 0.5 mm/10 m
Accuracy (inclination)						± 0.015%	± 0.015% H2N+ / ± 0.1% H2N		± 0.015%
Remote control	-	-	Infrared remote control	Infrared remote control			Radio remote control	Radio remote control	Radio remote control
Application:									
Casting concrete floors	***	***	***	*	***	***	***	***	***
Metre marking in interior work	***	**	**	**	***	***	***	***	***
Ceiling and dry wall construction	*	**	**	***	**	**	**	***	***
Use of batter boards	***		**	**				***	***
Bricklaying	***	**	***	*	**	**	**	***	***
Landscaping	***	*	*	*	*	***	***	**	***
Road construction	*	*	*	*	*	***	***	**	***
Interior finishing	**	**	***	***	**	**	**	**	**
Rough and fine grading	***	**	**	*	**	***	***	**	***
Depth control for excavations	**	***	***	*	**	**	**	***	***
Concrete formwork	***	*	*	*	*	*	*	***	***
Facade construction	**		**	*				***	***
Setting reference markers			*			***	***	*	***
Machine control applications					*** (900 rpm)	*** (900 rpm)	*** (750/900 rpm)		

* limited

** good

*** optimal

The robust aluminium multifunctional base permits exact positioning of the **LINUS 1 HV** over a known plumb point. With the fine adjustment you can exactly set the vertical laser lines of the **LINUS 1 HV** even over long distances.

The multifunctional foot is designed so that the laser can be positioned over tiles, allowing the vertical lines of the **LINUS 1 HV** to be aligned along the edges. The base additionally protects the laser from direct contact with wet soil, standing water or dirt.



The housing dimensions of the laser and **ACCEPTOR Line** laser receiver are perfectly matched. The distance between the vertical laser plane and the edge of the **LINUS 1 HV** is identical to that between the edge and zero line of the laser receiver. This makes it easy to check the perpendicularity of existing walls or formwork. Dimensional deviations can be read from the **ACCEPTOR Line** laser receiver with millimetre accuracy.



Scope of delivery **LINUS 1 HV**:
LINUS 1 HV, laser receiver
ACCEPTOR Line with mm display and Heavy-Duty rod clamp, multifunctional base with fine adjustment for precise axis alignment, rechargeable batteries and charger, laser glasses, target board and transport case
Ref.-No. 471 810



Supplied as a standard: **ACCEPTOR Line** digital laser receiver with **mm display**, and Heavy-Duty rod clamp made of aluminium, protection class IP 65



Video LINUS 1 HV

Nedo LINUS 1 HV

The versatile, robust universal laser with 90° function.

Nedo **LINUS 1 HV** is an extremely robust, fully automatic universal laser for levelling, aligning and marking off right angles for outdoor applications and interior finishing.

Features:

- Extremely robust
- Horizontal 360° laser line
- Four vertical, individually switchable laser lines at 90° angles, pointing down
- Plumb point
- Robust, motor-powered levelling
- Self-levelling range $\pm 5^\circ$
- Rugged housing protected against low pressure jet water in accordance with IP 65
- Connecting thread 5/8"
- Multifunctional base made of diecast aluminium with fine adjustment for precise axis alignment
- Laser receiver **ACCEPTOR Line with mm display** and Heavy-Duty rod clamp made of aluminium

Ideal for use on every construction site. Perfect for levelling, aligning and marking off right angles such as:

Gardening and landscaping:

- Paving
- Borders
- Car parks
- Terraces and sun decks

Structural and civil engineering:

- Marking off right angles in terrain
- Foundations
- Formwork and walls

Woodworking and carpentry:

- Timber post structures
- Sole plates
- Carports and 1:1 elevations

Steel construction:

- Columns
- Sleeve foundations
- Weld-on plates
- Conservatories

Nedo LINUS 1 HV

Ref.-No.	471 810
Levelling accuracy	$\pm 1 \text{ mm}/10 \text{ m}$
Self-levelling range	$\pm 5^\circ$ motor-powered, with automatic level control of the horizontal axis
Working range \varnothing	up to 200 m with receiver ACCEPTOR Line
Laser	Laser class 2M, 635 nm
Protection class	IP 65
Power supply	Rechargeable batteries NiMH 4,8 V, 3800 mAh
Vertical lines' angle of aperture	135°
Operation duration	approx. 30 h
Connecting thread	5/8"

Thanks to its ingenious seal, the **SIRIUS 1** rotating laser is protected against low pressure jet water in accordance with IP 65 and therefore meets sealing requirements expected of much more expensive rotating lasers. The new rotor protection made of cast aluminium and break-proof glass means the new **SIRIUS 1** is extremely robust.
The ergonomic rubber handle sits well in one's hand.
The **SIRIUS 1 H** and **HV** rotating lasers can optionally be supplied with laser class 2 or 3R.



Laser receiver **ACCEPTOR MAXX** with mm display, extra-large detector field and Heavy-Duty rod clamp

The ingeniously designed display can be seen from both the front and the side. The LEDs are extremely bright, allowing them to be read from a great distance



Nedo SIRIUS 1 H

	Ref.-No. laser class 3R	Ref.-No. laser class 2
SIRIUS 1 H Incl. laser receiver ACCEPTOR 2 digital with mm display and Heavy-Duty rod clamp, rechargeable batteries, charger and case	471 933	471 933-632
SIRIUS 1 H Incl. laser receiver ACCEPTOR MAXX with mm display and Heavy-Duty rod clamp, rechargeable batteries, charger and case	471 934	471 934-632
SIRIUS 1 H Set Incl. laser receiver ACCEPTOR MAXX with mm display and Heavy-Duty rod clamp, rechargeable batteries, charger, case, aluminium tripod (Ref.-No. 200 225), Flexi Rod with universal adapter and carrying bag	471 935	471 935-632

Calibration certificate for Nedo rotating lasers

Ref.-No.	399 556 calibration certificate for Nedo rotating lasers
----------	--



Scope of delivery **SIRIUS 1 H**:
Rotating laser **SIRIUS 1 H**, laser receiver **ACCEPTOR 2 digital with mm display** and Heavy-Duty rod clamp, rechargeable batteries, charger and transport case
Ref.-No. 471 933



Scope of delivery **SIRIUS 1 H**:
Rotating laser **SIRIUS 1 H**, laser receiver **ACCEPTOR MAXX** and Heavy-Duty rod clamp, rechargeable batteries, charger and transport case
Ref.-No. 471 934



SIRIUS 1 H Set inclusive:

- **SIRIUS 1 H** (Ref.-No. 471 934)
- Aluminium tripod, (Ref.-No. 200 225) working range 0.91 m to 1.69 m
- Flexi Rod with universal adapter and carrying bag

Ref.-No. 471 935

Nedo SIRIUS 1 H

The fully automatic horizontal rotating laser with Easy Control – the one-pushbutton operation for extremely easy handling.

The rotating laser offers fully automatic self-levelling. The automatic level control stops the laser if it receives a heavy jolt. In this way height errors are avoided. Simply switch it on and off you go!

Features:

- Fully automatic horizontal laser for exterior applications
- Self-levelling range $\pm 5^\circ$ motor-powered, with automatic level control
- High-power laser diode (3R) for very good laser beam visibility
- Alternatively available with laser class 2
- Automatic level control stops the laser if it receives a heavy jolt. In this way, height errors are avoided.
- Rugged housing protected against low pressure jet water in accordance with IP 65
- Rotor protection made of cast aluminium and break-proof glass
- High-power NiMH rechargeable batteries for long operation

Ideal for use on every construction site. Perfect for levelling in applications such as:

- Casting concrete floors
- Fine grading
- Metre marking in interior work
- Bricklaying
- Excavation work
- Landscaping

Nedo SIRIUS 1 H

Technical data:	
Levelling accuracy	± 1 mm/10 m
Self-levelling range	$\pm 5^\circ$ motor-powered, with automatic level control
Working range \emptyset	approx. 400 m with receiver
Laser	< 5 mW, laser class 3R, 635 nm or < 1 mW laser class 2, 635 nm
Rotating speed	600 rpm
Protection class	IP 65
Power supply	NiMH rechargeable batteries 4.8 V, 3800 mAh
Operation duration	approx. 30 h
Connecting thread	5/8"

Thanks to its ingenious seal, the **SIRIUS 1** rotating laser is protected against low pressure jet water in accordance with IP 65 and therefore meets sealing requirements expected of much more expensive rotating lasers. The new rotor protection made of cast aluminium and break-proof glass means the new **SIRIUS 1** is extremely robust. The ergonomic rubber handle sits well in one's hand. The **SIRIUS 1 H** and **HV** rotating lasers can optionally be supplied with laser class 2 or 3R.

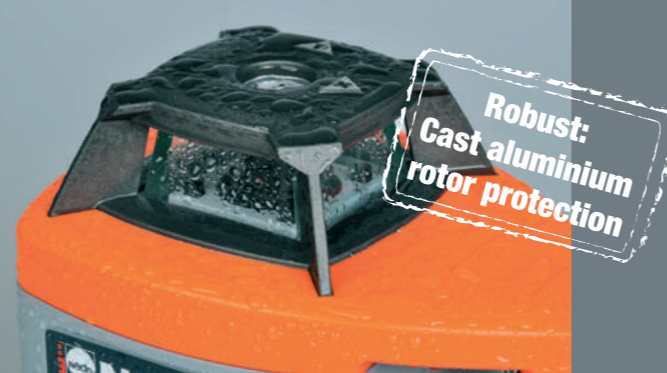

Laser receiver **ACCEPTOR MAXX** with mm display, extra-large detector field and Heavy-Duty rod clamp

The ingeniously designed display can be seen from both the front and the side. The LEDs are extremely bright, allowing them to be read from a great distance



Scope of delivery **SIRIUS 1 HV**:
Rotating laser **SIRIUS 1 HV**, laser receiver **ACCEPTOR MAXX** with mm display and Heavy-Duty rod clamp, rechargeable batteries, charger, remote control and case
Ref.-No. 471 946



SIRIUS 1 HV Set 1 inclusive:

- **SIRIUS 1 HV** (Ref.-No. 471 946)
- Elevating tripod, (Ref.-No. 210 621) working range 0.80 m to 2.76 m
- Flexi Rod with universal adapter and carrying bag

Ref.-No. 471 947

SIRIUS 1 HV Set 2 inclusive:

- **SIRIUS 1 HV** (Ref.-No. 471 946)
- Elevating tripod, (Ref.-No. 210 616) working range 0.78 m to 2.03 m
- Flexi Rod with universal adapter and carrying bag

Ref.-No. 471 948



Scope of delivery **SIRIUS 1 HV Set 3**:
Rotating laser **SIRIUS 1 HV**, laser receiver **ACCEPTOR MAXX** with mm display and Heavy-Duty rod clamp, wall mount, vertical mount, rechargeable batteries, charger, remote control and case
Ref.-No. 471 949

Nedo SIRIUS 1 HV

The fully automatic horizontal/vertical rotating laser for clever craftsmen. It is ideal for levelling and aligning in interior outfitting and construction. **SIRIUS 1 HV** combines optimum functionality, a full range of features and an attractive price-performance ratio.

Features:

- Fully automatic horizontal/vertical laser for interior outfitting and exterior applications
- High-power laser diode (laser class 3R) for very good laser beam visibility
- Alternatively available with laser class 2
- Automatic level control stops the laser if it receives a heavy jolt. In this way, height errors are avoided.
- Upward and downward plumb beam
- Manual setting of slopes in 2 axes
- Scanning function and dot mode
- Rugged housing protected against low pressure jet water in accordance with IP 65
- Rotor protection made of cast aluminium and break-proof glass
- High-power NiMH rechargeable batteries for long operation
- Remote control for a convenient handling

Ideal for use on every construction site. Perfect for levelling in applications such as:

- Casting concrete floors
- Metre marking in interior work
- Dry wall construction
- Use of batter boards
- Laying screed
- Masonry and excavation work
- Landscaping
- Interior construction

Nedo SIRIUS 1 HV

Technical data:	
Levelling accuracy	± 1 mm/10 m
Self-levelling range	± 5° motor-powered, with automatic level control
Working range Ø	approx. 300 m with receiver
Laser	< 5 mW, laser class 3R, 635 nm or < 1 mW laser class 2, 635 nm
Rotating speed	0, 60, 120, 300 and 600 rpm
Scanning angle	0°, 6°, 20°, 50° and 90°
Protection class	IP 65
Power supply	NiMH rechargeable batteries 4.8 V, 3800 mAh
Operation duration	approx. 30 h
Connecting thread	5/8"

Nedo SIRIUS 1 HV

	Ref.-No. laser class 3R	Ref.-No. laser class 2
SIRIUS 1 HV Incl. laser receiver ACCEPTOR 2 digital with mm display and Heavy-Duty rod clamp, remote control, rechargeable batteries, charger and case	471 945	471 945-632
SIRIUS 1 HV Incl. laser receiver ACCEPTOR MAXX with mm display and Heavy-Duty rod clamp, remote control, rechargeable batteries, charger and case	471 946	471 946-632
SIRIUS 1 HV Set 1 Incl. laser receiver ACCEPTOR MAXX with mm display and Heavy-Duty rod clamp, remote control, rechargeable batteries, charger, case, elevating tripod (Ref.-No. 210 621), Flexi Rod with universal adapter and carrying bag	471 947	471 947-632
SIRIUS 1 HV Set 2 Incl. laser receiver ACCEPTOR MAXX with mm display and Heavy-Duty rod clamp, remote control, rechargeable batteries, charger, case, elevating tripod (Ref.-No. 210 621), Flexi Rod with universal adapter and carrying bag	471 948	471 948-632
SIRIUS 1 HV Set 3 Incl. laser receiver ACCEPTOR MAXX with mm display and Heavy-Duty rod clamp, remote control, wall mount, vertical mount, rechargeable batteries, charger, case	471 949	471 949-632

Calibration certificate for Nedo rotating lasers

Ref.-No.	399 556 calibration certificate for Nedo rotating lasers
----------	--

Green laser lines are four times as visible to the human eye as red lines. Owing to the excellent visibility of its green laser line, the Nedo **SIRIUS 1 HV green** rotating laser has a much bigger working range in which a laser receiver is not needed. Thanks to innovative laser technology, the laser in the **SIRIUS 1 HV green** does not have the operating temperature disadvantages that used to be typical of green lasers. The Nedo **SIRIUS 1 HV green** rotating laser can thus operate in the same temperature range as the **SIRIUS 1 HV** with red laser diodes.

The Nedo **SIRIUS 1 HV green** can be supplied with a class 2 or class 3R laser.



Laser class
2 or 3R



Nedo SIRIUS 1 HV green

	Ref.-No. laser class 3R	Ref.-No. laser class 2
SIRIUS 1 HV green Incl. laser receiver ACCEPTOR green with rod clamp, remote control, rechargeable batteries, charger and case	471 950	471 950-632
SIRIUS 1 HV green Set 1 Incl. laser receiver ACCEPTOR green with rod clamp, remote control, rechargeable batteries, charger, case, elevating tripod (Ref.-No. 210 621), Flexi Rod with universal adapter and carrying bag	471 951	471 951-632
SIRIUS 1 HV Set green Set 2 Incl. laser receiver ACCEPTOR green with rod clamp, remote control, rechargeable batteries, charger, target board, wall mount, vertical mount, rechargeable batteries and case	471 952	471 952-632

Calibration certificate for Nedo rotating lasers

Ref.-No.	399 556 calibration certificate for Nedo rotating lasers
----------	--



Scope of delivery **SIRIUS 1 HV green**:
Rotating laser **SIRIUS 1 HV green**, laser receiver **ACCEPTOR green** with rod clamp, rechargeable batteries, charger, remote control and transport case
Ref.-No. 471 950



SIRIUS 1 HV Set 1 inclusive:

- **SIRIUS 1 HV green** (Ref.-No. 471 950)
- Elevating tripod, (Ref.-No. 210 621) working range 0.80 m to 2.76 m
- Flexi Rod with universal adapter and carrying bag

Ref.-No. 471 951



Scope of delivery **SIRIUS 1 HV green Set 2**:
Rotating laser **SIRIUS 1 H green**, laser receiver **ACCEPTOR green** with rod clamp, target board, wall mount, vertical mount, rechargeable batteries, charger, remote control and transport case
Ref.-No. 471 952

Nedo SIRIUS 1 HV green

The green horizontal/vertical rotating laser for optimum visibility in interior finishing.

The green laser beam guarantees optimum visibility, even under unfavourable lighting conditions. It permits working without a laser receiver even in bright daylight, with dark surfaces or over long distances.

Features:

- Fully automatic horizontal/vertical rotating laser for interior finishing and outdoor missions
- Green laser beam with high-power laser diode (laser class 3R) for optimum visibility, even under unfavourable lighting conditions
- Automatic level control stops the laser if it receives a heavy jolt. In this way, height errors are avoided.
- Upward and downward plumb beam
- Manual setting of slopes in 2 axes
- Scanning function and dot mode
- Rugged housing protected against low pressure jet water in accordance with IP 65
- Rotor protection made of cast aluminium and break-proof glass
- High-power NiMH rechargeable batteries for long operation
- Remote control for a convenient handling

Ideal for interior applications. Perfect for levelling and aligning jobs, especially in the following areas:

- Dry wall construction
- Ceiling construction
- Laying screed
- Steel construction
- Interior construction
- Installation of windows
- Installation of doors

Nedo SIRIUS 1 HV green

Technical data:	
Levelling accuracy	± 1 mm/10 m
Self-levelling range	± 5° motor-powered, with automatic level control
Working range Ø	approx. 300 m with receiver
Laser	< 5 mW, laser class 3R, 515 nm or < 1 mW, laser class 2, 515 nm
Operating temperature	-20°C to +50°C
Rotating speed	0, 60, 120, 300 and 600 rpm
Scanning angle	0°, 6°, 20°, 50° and 90°
Protection class	IP 65
Power supply	rechargeable batteries NiMH 4.8 V, 3800 mAh
Operation duration	approx. 15 h
Connecting thread	5/8"

Nedo **PRIMUS 2**, the series of fully automatic rotating lasers for professionals. Ideal for levelling, aligning and grade control. Reliable and rugged for tough construction jobs. Uncompromising quality for professionals. All **PRIMUS 2** models can be supplied with laser class 3R or laser class 2 with Bright Beam technology™.

The **PRIMUS 2** series sets a new standard for fully automatic rotating lasers. High technology made in Germany.



3-year warranty for all PRIMUS 2 models



The Fully Automatic Rotating Lasers Made in Germany



PRIMUS 2 - The Standard for Fully Automatic Rotating Lasers



Setting Standards for Precision and Reliability

The rotating lasers of the **PRIMUS 2** series remain extraordinarily precise whatever the site conditions – in continuous rainfall, severe cold or blazing heat. Whether horizontal, vertical or at a gradient.

Always reliable, whenever and wherever they are used.

The **PRIMUS 2** casing is protected against jet water and dust in line with IP 66. After use, the **PRIMUS 2** can even be sprayed down with water to clean it.



The Standard for Ruggedness

Thanks to their innovative shock protection system, the rotating lasers of the **PRIMUS 2** series can easily withstand a fall from a height of 1 m. The thick lining and rotor protection provide additional safety.



Setting Standards for Visibility

All **PRIMUS 2** rotating lasers are fitted with high-quality laser diodes with 635 nm wavelength. The customer can choose between high-power laser diodes in laser class 3R or laser diodes in laser class 2 featuring Bright Beam Technology™ thus ensuring optimum visibility of the laser beam even under unfavourable light conditions.

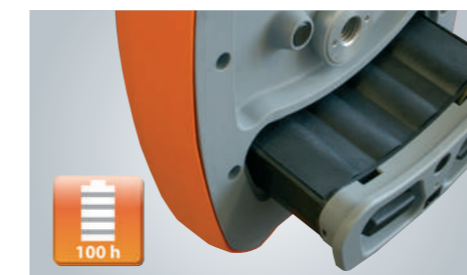

The Standard for Long Life

High-power rechargeable NiMH batteries with Eneloop™ technology ensure a long operating life of more than 100 hours, with minimal self-discharging. The intelligent power compartment permits quick changing between battery and rechargeable battery operation.



Setting Standards for Easy Operation

Are you fed up with difficult-to-handle devices?

All **PRIMUS 2** lasers feature in addition to the standard 5/8" mounting thread the Quick-Fix rapid locking system which allows the laser device to be fixed in just a few seconds to any tripod and just as quickly detached. Just throw the lever for fixing or detaching.

That's all!

Laser receiver ACCEPTOR MAXX with mm display, extra-large detector field and Heavy-Duty rod clamp

The ingeniously designed display can be seen from both the front and the side. The LEDs are extremely bright, allowing them to be read from a great distance



PRIMUS 2 H

PRIMUS 2 H available with 900 rpm.
Perfect for machine control applications.
Ref.-No. 399 602



Nedo PRIMUS 2 H

	Ref.-No. laser class 3R	Ref.-No. laser class 2
PRIMUS 2 H Incl. transport case, laser receiver ACCEPTOR MAXX with mm display, Heavy-Duty rod clamp, Quick-Fix, rechargeable batteries and charger	472 018	472 018-632
PRIMUS 2 H Incl. transport case, Quick-Fix, rechargeable batteries and charger	472 016	472 016-632
Upgrade PRIMUS 2 H to 900 rpm	399 602	399 602

Calibration certificate for Nedo rotating lasers

Ref.-No.	399 556 calibration certificate for Nedo rotating lasers
----------	--



Scope of delivery **PRIMUS 2 H**:
Rotating laser **PRIMUS 2 H**, laser receiver **ACCEPTOR MAXX** with mm display, Heavy-Duty rod clamp, rechargeable batteries and charger, Quick-Fix rapid locking system and transport case
Ref.-No. 472 018

Nedo PRIMUS 2 H

The fully automatic horizontal rotating laser

Features:

- Fully automatic rotating laser for horizontal applications
- Robust, motor-powered levelling
- Automatic level control stops the laser if it receives a heavy jolt. In this way, height errors are avoided.
- High-power laser diode, laser class 3R, for highly visible laser beam and easy work at the close range
- Alternatively available with laser class 2 with Bright Beam Technology™
- Large, clear display showing rotation speed, battery level, etc.
- Rotor protection made of break-proof glass
- Laser receiver **ACCEPTOR MAXX** with Heavy-Duty rod clamp made of diecast aluminium
- Extremely easy to use
- Highly accurate even under toughest conditions
- Available on request with a rotation speed of 900 rpm perfect for machine control applications

Ideal for use on every construction site. Perfect for levelling in applications such as:

- Rough and fine grading
- Depth control for excavations
- Casting concrete
- Bricklaying
- Landscaping
- Machine control



Optional accessory "Outdoor package":

- Aluminium tripod, (Ref.-No. 200 225) working range 0.91 m to 1.69 m
- Flexi Rod with universal adapter and carrying bag

Ref.-No. 200 350

Nedo PRIMUS H

Technical data:	
Levelling accuracy	± 0.5 mm/10 m
Self-levelling range	± 5° motor-powered, with automatic level control
Working range Ø	approx. 700 m with receiver ACCEPTOR MAXX
Laser	< 5 mW, laser class 3R, 635 nm or < 1mW, laser class 2, 635 nm
Rotating speed	600 rpm or 900 rpm
Protection class	IP 66
Power supply	rechargeable batteries NiMH 4.8 V, 8500 mAh
Operation duration	approx. 100 h
Connecting thread	5/8"

Single slope function

For horizontal use and for slopes in one axis

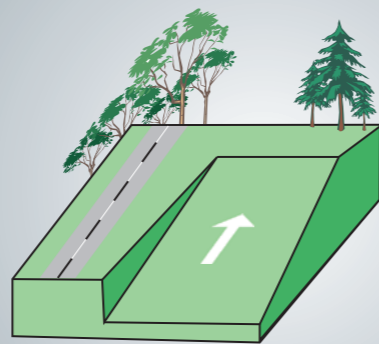

Optional accessory:
Telescopic sight with
laser sighting mechanism
Ref.-No. 461 096

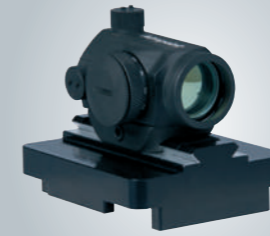

PRIMUS 2 H1N+ Long Range

PRIMUS 2 H1N+ Long range
available with 750 rpm or 900 rpm.
Perfect for machine control
applications.

Ref.-No. 399 604 (750 rpm)
Ref.-No. 399 602 (900 rpm)



Nedo PRIMUS 2 H1N+ Long Range

	Ref.-No. laser class 3R	Ref.-No. laser class 2
PRIMUS 2 H1N+ Long Range Incl. Quick-Fix, rechargeable batteries, charger and transport case	472 025	472 025-632
PRIMUS 2 H1N+ Long Range with ACCEPTOR MAXX Incl. laser receiver ACCEPTOR MAXX, Quick-Fix, rechargeable batteries, charger and transport case	472 026	472 026-632
Upgrade PRIMUS 2 H1N+ Long Range to 750 rpm	399 604	399 604
Upgrade PRIMUS 2 H1N+ Long Range to 900 rpm	399 602	399 602

Calibration certificate for Nedo rotating lasers

Ref.-No.	399 556 calibration certificate for Nedo rotating lasers
----------	--

Nedo PRIMUS 2 H1N+ Long Range

Fully automatic single slope laser with tilt control and automatic re-levelling when in slope mode. Extremely large working range for use with machine control applications.

Features:

- Fully automatic single slope laser
- Robust, motor-powered levelling
- Direct grade entry for the y axis
- Slope value once input is stored beyond switch-off
- Tilt control: the position of the laser plane is continuously monitored in the slope mode and re-levelled if necessary.
- Automatic level control stops the laser if it receives a heavy jolt. In this way, height errors are avoided.
- Large, clear display showing inclination, rotation speed, battery level, etc.
- High-power laser diode, laser class 3R
- Alternatively available with laser class 2 with Bright Beam Technology™
- Rotor protection made of break-proof glass
- Highly accurate even under toughest conditions
- **PRIMUS 2 H1N+ Long Range** available on request with a rotation speed of 750 or 900 rpm perfect for machine control applications

Ideal for use on every construction site. Perfect for levelling in applications such as:

- Machine control
- Elevation control
- Rough and fine grading
- Depth control for excavations
- Casting concrete
- Bricklaying
- Setting foundations and footings
- Landscaping

Nedo PRIMUS 2 H1N+ Long Range

Technical data:	
Levelling accuracy	± 0.5 mm/10 m
Self-levelling range	± 5° motor-powered, with automatic level control
Setting of slope function	± 10 %
Accuracy of the slope function	better than ± 0,015 %
Working range Ø	approx. 1000 m with excavator receiver
Laser	< 5 mW, laser class 3R, 635 nm or < 1mW, laser class 2, 635 nm
Rotating speed	600 rpm, 750 rpm or 900 rpm
Protection class	IP 66
Power supply	rechargeable batteries NiMH 4.8 V, 8500 mAh
Operation duration	approx. 100 h
Connecting thread	5/8"



Scope of delivery **PRIMUS 2 H1N+ Long Range**:
Rotating laser **PRIMUS 2 H1N+ Long Range**,
rechargeable batteries, charger, Quick-Fix rapid
locking system and transport case
Ref.-No. 472 025



Scope of delivery **PRIMUS 2 H1N+ Long Range**
with ACCEPTOR MAXX:
Rotating laser **PRIMUS 2 H1N+ Long Range**,
laser receiver **ACCEPTOR MAXX**, rechargeable
batteries, charger, Quick-Fix rapid locking
system and transport case
Ref.-No. 472 026



Optional accessory:
Laser receiver **ACCEPTOR M**
See on page 57

mm display

Supplied as standard with laser receiver COMMANDER 2 with mm display and practically indestructible all-metal clamp made of diecast aluminium



Dual slope function
For horizontal use and for slopes in one or two axes

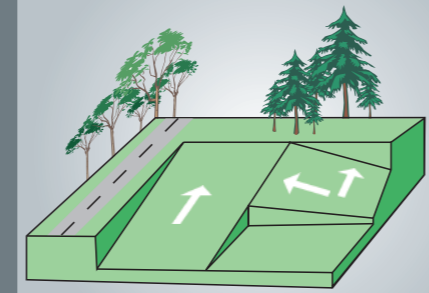

Optional accessory:
Telescopic sight with laser sighting mechanism
Ref.-No. 461 096

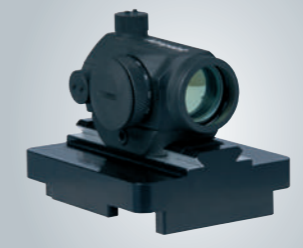

PRIMUS 2 H2N+
PRIMUS 2 H2N+ available with 750 or 900 rpm. Perfect for machine control applications.
Ref.-No. 399 604 (750 rpm)
Ref.-No. 399 602 (900 rpm)



-
-
-
-
-
-
-
-
-



MADE IN GERMANY

Nedo PRIMUS 2 H2N+ / PRIMUS 2 H2N

	Ref.-No. laser class 3R	Ref.-No. laser class 2
PRIMUS 2 H2N+ with tilt control Incl. multi-function module COMMANDER 2 H2N+ (laser receiver incl. radio remote control) with mm display, Heavy-Duty rod clamp, Quick-Fix, rechargeable batteries, charger and transport case	472 034	472 034-632
PRIMUS 2 H2N+ with tilt control Incl. laser receiver ACCEPTOR MAXX , Heavy-Duty rod clamp, Quick-Fix, rechargeable batteries, charger and transport case	472 037	472 037-632
PRIMUS 2 H2N+ with tilt control Incl. Quick-Fix, rechargeable batteries, charger and transport case	472 033	472 033-632
Upgrade PRIMUS 2 H2N+ auf 750 rpm	399 604	399 604
Upgrade PRIMUS 2 H2N+ auf 900 rpm	399 602	399 602
PRIMUS 2 H2N Incl. Quick-Fix, transport case, rechargeable batteries and charger	472 030	472 030-632
PRIMUS 2 H2N Incl. multi-function module COMMANDER 2 H2N (laser receiver incl. radio remote control) with mm display, Heavy-Duty rod clamp, Quick-Fix, rechargeable batteries, charger and transport case	472 031	472 031-632
PRIMUS 2 H2N Incl. laser receiver ACCEPTOR MAXX , Heavy-Duty rod clamp, rechargeable batteries, charger and transport case	472 036	472 036-632

Calibration certificate for Nedo rotating lasers

Ref.-No.	399 556 calibration certificate for Nedo rotating lasers
----------	--

Nedo PRIMUS 2 H2N+

Fully automatic dual slope laser with tilt control and automatic re-levelling when in slope mode.

Nedo PRIMUS 2 H2N

Fully automatic dual slope laser

Features:

- Fully automatic dual slope laser
- Robust, motor-powered levelling
- Direct grade entry for the x and y axes
- Slope values once input are stored beyond switch-off
- **PRIMUS 2 H2N+** with tilt control: the position of the laser plane is continuously monitored in the slope mode and re-levelled if necessary.
- Automatic level control stops the laser if it receives a heavy jolt. In this way, height errors are avoided.
- Large, clear display showing inclination, rotation speed, battery level, etc.
- High-power laser diode, laser class 3R, for highly visible laser beam and easy work at the close range
- Alternatively available with laser class 2 with Bright Beam Technology™
- Rotor protection made of break-proof glass
- Highly accurate even under toughest conditions
- **PRIMUS 2 H2N+** available on request with a rotation speed of 750 or 900 rpm perfect for machine control applications

Ideal for use on every construction site. Perfect for levelling in applications such as:

- Elevation control
- Casting concrete
- Rough and fine grading
- Bricklaying
- Depth control for excavations
- Setting foundations and footings
- Machine control
- Landscaping

Nedo PRIMUS 2 H2N+ and H2N

Technical data:	
Levelling accuracy	± 0.5 mm/10 m
Self-levelling range	± 5° motor-powered, with automatic level control
Setting of slope function	± 10%, direct entry
Accuracy of the slope function	± 0.015% PRIMUS 2 H2N+, ± 0.1% PRIMUS 2 H2N
Working range Ø	approx. 700 m with receiver COMMANDER 2 H2N
Laser	< 5 mW, laser class 3R, 635 nm or < 1mW, laser class 2, 635 nm
Rotating speed	600 rpm, 750 rpm or 900 rpm (H2N+)
Protection class	IP 66
Power supply	rechargeable batteries NiMH 4.8 V, 8500 mAh
Operation duration	approx. 100 h
Connecting thread	5/8"



Scope of delivery **PRIMUS 2 H2N+**:
Rotating laser **PRIMUS 2 H2N+**, laser receiver **COMMANDER 2 H2N+** with mm display, Heavy-Duty rod clamp, rechargeable batteries, charger, Quick-Fix rapid locking system and transport case
Ref.-No. 472 034-632



Optional accessory "**Optional accessory**":
- Aluminium tripod, (Ref.-No. 200 225) working range 0.91 m to 1.69 m
- Flexi Rod with universal adapter and carrying bag
Ref.-No. 200 350

mm display

Supplied as standard with laser receiver COMMANDER 2 with mm display and practically indestructible all-metal clamp made of diecast aluminium



The AutoAlign function eliminates the need for tiresome manual alignment of the laser plane on the laser receiver, saving considerable time when batter boards are used and in facade construction. Batter board and facade construction adapters are available as optional accessories for the PRIMUS 2 and the COMMANDER 2 laser receiver.



AutoAlign Video

AutoAlign function

At the push of a button, the laser plane automatically aligns with the laser receiver **COMMANDER 2 HVA**. Ideal when batter boards are used or on facade construction. The working range of the AutoAlign function is 50 metres.



Scope of delivery **PRIMUS 2 HVA**: Rotating laser **PRIMUS 2 HVA**, laser receiver **COMMANDER 2 HVA with mm display**, Heavy-Duty rod clamp, rechargeable batteries, charger, Quick-Fix rapid locking system and transport case
Ref.-No. 472 050-632

Nedo PRIMUS 2 HVA

The fully automatic horizontal/vertical rotating laser with AutoAlign function

Features:

- Fully automatic rotating laser for horizontal and vertical applications
- AutoAlign function: automatic alignment of the laser beam to the zero mark of the laser receiver
- Robust motor-powered levelling
- Large, clear display showing rotation speed, battery level, etc.
- Automatic level control stops the laser if it receives a heavy jolt. In this way, height errors are avoided.
- Manual setting of slopes in 2 axes
- Scan function and dot mode
- High-power laser diode, laser class 3R, for highly visible laser beam and easy work at the close range
- Alternatively available with laser class 2 with Bright Beam Technology™
- Upward plumb beam
- Rotor protection made of break-proof glass
- Highly accurate even under toughest conditions
- Incl. multi-function module COMMANDER 2 HVA, laser receiver incl. radio remote control

Ideal for interior applications. Perfect for levelling and aligning jobs, especially in the following areas:

- Depth control for excavations
- Concrete casting
- Concrete formwork
- Use of batter boards
- Bricklaying
- Laying screed
- Drywall installation
- Ceiling construction
- Facade construction



Optional accessory **"Accessory package 1"**:

- Elevating tripod, (Ref.-No. 210 621) working range 0.80 m to 2.76 m
- Flexi Rod with universal adapter and carrying bag

Ref.-No. 210 350

Optional accessory **"Accessory package 2"**:

- Elevating tripod, (Ref.-No. 210 616) working range 0.78 m to 2.03 m
- Flexi Rod with universal adapter and carrying bag

Ref.-No. 210 351

Nedo PRIMUS 2 HVA

Technical data:	
Levelling accuracy	± 0.5 mm/10 m
Self-levelling range	± 5° motor-powered, with automatic level control
Setting of slopes in two axes	manual
Working range Ø	approx. 500 m with receiver COMMANDER 2 HVA
Laser	< 5 mW, laser class 3R, 635 nm or < 1mW, laser class 2, 635 nm
Working range radio remote control	approx. 150 m
Working range AutoAlign	approx. 50 m
Rotating speed	10, 60, 300 and 600 rpm
Scanning angle	0°, 5°, 10° and 15°
Protection class	IP 66
Power supply	rechargeable batteries NiMH 4.8 V, 8500 mAh
Operation duration	approx. 100 h
Connecting thread	5/8"

Nedo PRIMUS 2 HVA

	Ref.-No. laser class 3R	Ref.-No. laser class 2
--	-------------------------	------------------------

PRIMUS 2 HVA

472 050

472 050-632

Incl. multi-function module **COMMANDER 2 HVA** (laser receiver incl. radio remote control) with mm display, Heavy-Duty rod clamp, Quick-Fix, rechargeable batteries, charger and transport case

Calibration certificate for Nedo rotating lasers

Ref.-No.	399 556 calibration certificate for Nedo rotating lasers
----------	--

mm display

Supplied as standard with laser receiver COMMANDER 2 with mm display and practically indestructible all-metal clamp made of diecast aluminium



Dual slope function
For horizontal use and for slopes in one or two axes

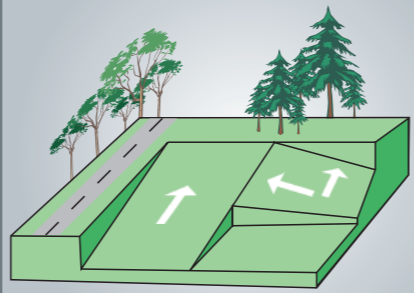

Vertical alignment aid
In vertical operation the laser can be exactly aligned with the help of a laser line

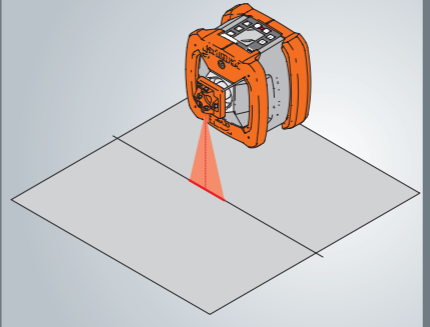

AutoAlign function
At the push of a button, the laser plane automatically aligns with the laser receiver COMMANDER 2 HVA2N. Ideal when batter boards are used or on facade construction.



-
-
-
-
-
-
-
-
-
-
-
-



MADE IN GERMANY



Scope of delivery **PRIMUS 2 HVA2N**: Rotating laser **PRIMUS 2 HVA2N**, laser receiver **COMMANDER 2 HVA2N with mm display**, Heavy-Duty rod clamp, rechargeable batteries, charger, Quick-Fix rapid locking system and transport case
Ref.-No. 472 061-632



Optional accessory **"Accessory package 1"**:
- Elevating tripod, (Ref.-No. 210 621) working range 0.80 m to 2.76 m
- Flexi Rod with universal adapter and carrying bag
Ref.-No. 210 350

Optional accessory **"Accessory package 2"**:
- Elevating tripod, (Ref.-No. 210 616) working range 0.78 m to 2.03 m
- Flexi Rod with universal adapter and carrying bag
Ref.-No. 210 351

Nedo PRIMUS 2 HVA2N

The fully automatic horizontal/vertical dual slope laser with AutoAlign function

Features:

- Fully automatic rotating laser for horizontal and vertical applications
- Direct grade entry for the x and y axis
- Tilt control: the position of the laser is continuously monitored in the tilt mode
- AutoAlign function: automatic alignment of the laser beam to the zero mark of the laser receiver
- Robust motor-powered levelling
- Large, clear display showing inclination, rotation speed, battery level, etc.
- Automatic level control stops the laser if it receives a heavy jolt. In this way, height errors are avoided.
- High-power laser diode, laser class 3R, for highly visible laser beam and easy work at the close range
- Alternatively available with laser class 2 with Bright Beam Technology™
- Scan function and dot mode
- Upward plumb beam
- Rotor protection made of break-proof glass
- Highly accurate even under toughest conditions
- Incl. multi-function module COMMANDER 2 HVA2N, laser receiver incl. radio remote control

Ideal for use on every construction site. Perfect for levelling in applications such as:

- Depth control for excavations
- Concrete casting
- Setting foundations and footings
- Concrete casting
- Use of batter boards
- Bricklaying
- Landscaping
- Laying screed
- Facade construction
- Setting reference markers
- Rough and fine grading
- Ceiling construction

Nedo PRIMUS 2 HVA2N

Technical data:	
Levelling accuracy	± 0.5 mm/10 m
Self-levelling range	± 5° motor-powered, with automatic level control
Accuracy of the slope function	± 0.015%
Setting of slopes in two axes	± 10%, direct entry
Working range Ø	approx. 700 m with receiver COMMANDER 2 HVA2N
Laser	< 5 mW, laser class 3R, 635 nm or < 1mW, laser class 2, 635 nm
Working range radio remote control	approx. 150 m
Working range AutoAlign	approx. 50 m
Rotating speed	10, 60, 300 and 600 rpm
Scanning angle	0°, 5°, 10° and 15°
Protection class	IP 66
Power supply	rechargeable batteries NiMH 4.8 V, 8500 mAh
Operation duration	approx. 100 h
Connecting thread	5/8"

Nedo PRIMUS 2 HVA2N

	Ref.-No. laser class 3R	Ref.-No. laser class 2
--	-------------------------	------------------------

PRIMUS 2 HVA2N	472 061	472 061-632
Incl. multi-function module COMMANDER 2 HVA2N (laser receiver incl. radio remote control) with mm display, Heavy-Duty rod clamp, Quick-Fix, rechargeable batteries, charger and transport case		

Calibration certificate for Nedo rotating lasers

Ref.-No.	399 556 calibration certificate for Nedo rotating lasers
----------	--



Nedo Pipe Laser TUBUS 2

Green. Easy to operate. Extremely robust.

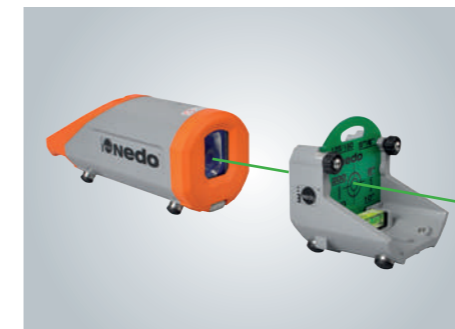

Visibility: outstanding

Green laser beams are four times as visible to the human eye as red beams with the same power. For this reason, the Nedo **TUBUS 2** Pipe Laser is fitted as standard with a green laser diode that is optionally available with laser class 2 or 3R. The green laser dot of the **TUBUS 2** is easy to see on the height-adjustable target board, even in unfavourable light conditions. This high visibility means that jobs can be completed much faster.



Operating concept: smart

The sophisticated SmartControl operating concept of the **TUBUS 2** Pipe Laser ensures easy, intuitive handling: All important data, including the gradient, cross slope, axis alignment and battery level, are clearly shown on the well-arranged OLED display on both, the laser and the remote control. The combined radio and infrared remote control ensures top transmission performance both in and above the pipe. The display and keypad of the pipe laser and remote control are identically configured to ensure intuitive operation. Frequently used functions can be accessed at the touch of a button. The axes are aligned using the manual alignment function. Compensation for cross slope is automatic, also for plumbing.



Robustness: no compromises

Sturdily built to meet the demands of professionals. Reliable performance for gruelling use in heavy construction. The rugged aluminium housing has an IP 68 protection rating. The shock-protection system of the **TUBUS 2** protects sensors and electronic components even under the toughest conditions. The Nedo **TUBUS 2** makes no compromises – Made in Germany.



Extremely compact

The compact design of the TUBUS 2 Pipe Laser enables it to be used in narrow pipes with diameters of 125 mm and more and in tight pipe bends. Insertion into small-diameter pipes is simplified by the innovative pipe slider, a rugged metal wheel on the underside of the laser.



Nedo Pipe Laser TUBUS 2

Green. Easy to operate. Extremely robust.

Features:

- Green laser diode for top visibility, optionally available with laser class 2 or 3R
- SmartControl for simple, intuitive operation
- Extremely robust design, IP 68 submersion protection
- Compact dimensions for use in tight pipe bends and pipes with diameters of 125 mm and more
- Laser and remote control with OLED display for easy read-offs
- Combined radio and infrared remote control for top transmission performance
- Manual alignment function
- Inclination measurement function
- Cross slope compensation, also for plumbing
- Adjustable vibration sensitivity
- Pipe slider for simple insertion of the laser into small-diameter pipes
- Plumb LED upwards
- 5/8" tripod thread
- Li-Ion battery for long periods of use
- Battery charger for simultaneous charging of the laser and the remote control
- Sets of feet for 150 mm, 200 mm, 250 mm and 300 mm pipe diameters
- Height-adjustable target board



Scope of delivery **TUBUS 2**:
Pipe laser **TUBUS 2**, radio remote control, height-adjustable target board, sets of feet for 150 mm, 200 mm, 250 mm and 300 mm pipe diameters, battery charger, sturdy transport case
Ref.-No. 472 210

Nedo TUBUS 2

Ref.-No.	472 210 laser class 3R
Ref.-No.	472 210-632 laser class 2
Levelling accuracy	± 0.05 mm/m
Self-levelling range	-15 % to +40 %
Gradient range	-15 % to +40 %
Horizontal adjustment range	± 10°
Display resolution	0.001 %
Laser	green laser diode, laser class 3R or 2
Operating temperature	-20°C to +50°C
Protection class	IP 68
Operation duration	up to 40 h
Weight	3.5 kg
Dimensions	ø 120 mm, length 300 mm
Warranty	Pipe laser 3 years remote control 1 year rechargeable Li-Ion battery 6 month



Remote control with bidirectional wireless link and additional infra-red module for top transmission performance under any operating conditions



Heavy-Duty Rod Clamp
Ref.-No. 062 424-900

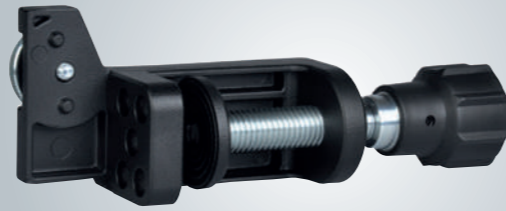

mm display

Nedo Laser Receiver for Rotating Lasers

ACCEPTOR 2 digital with mm display

The laser receiver **ACCEPTOR 2 digital** with mm display shows digitally the divergence of the zero line of the laser receiver from the laser plane of the rotating laser. With the mm display, height differences during levelling can be read off directly – without calculation.

Features:

- Robust laser receiver for all rotating lasers with a red laser beam
- Large detector field of 50 mm length
- Readout of height difference in mm
- Large illuminated LC displays on the front and back
- Size of directional arrows is proportional to difference in height
- Bright LED display
- 3 accuracy settings: ± 1 mm, ± 4 mm and ± 6 mm
- Battery status shown in display
- Switchable acoustic signal
- Bubble for easy alignment
- Strong magnets for fixing to steel girders
- Automatic shut-off after 15 min.
- Nedo heavy-duty rod clamp and batteries supplied as standard



Ref.-No 062 247

Nedo ACCEPTOR 2 digital

Ref.-No.	430 338
Accuracy	switchable, ± 1 mm, ± 4 mm and ± 6 mm
Working range	\emptyset 550 m (depends on laser)
Length of detector field	50 mm
Reception angle	$\pm 65^\circ$
Protection class	IP 67
Operating temperature	-20°C to +50°C
Power supply	2 x 1.5 V batteries (AA) or rechargeable batteries (NiMH)
Operation duration	up to 120 h

Optional Accessory:

Multifunctional rod clamp with patented quick clamp and batter board function

Features:

- Quick and easy attachment with the quick clamp
- Flat positioning of the laser receiver on a wall
- Around-the-corner applications are no problem for the multifunctional receiver holder
- Quick and easy attachment to the batter board

Ref.-No. 062 247



Quick and easy attachment to the batter board



Nedo ACCEPTOR MAXX

Nedo **ACCEPTOR MAXX** is a new digital laser receiver with a mm display and an extra-large detector field. The robust housing and virtually indestructible Nedo heavy-duty rod clamp make the new **ACCEPTOR MAXX** perfect for use under harsh conditions.

Large illuminated digital LC displays on the front and back show the deviation of the zero line of the **ACCEPTOR MAXX** from the plane of the rotation laser. The easy-to read displays allow you to read off height differences directly in mm, without calculation.

In addition, extremely bright LEDs show the position of the laser receiver in relation to the laser plane. The ingeniously designed housing allows the LEDs to be seen from the front and the side, even from a great distance. Furthermore, an acoustic signal indicates the position of the laser receiver.

Features:

- Robust laser receiver for all rotating lasers with a red laser beam
- Extra-large 120 mm detector field
- Large illuminated LC displays on the front and back
- Readout of height difference in mm
- Size of directional arrows is proportional to difference in height
- Bright LED display, visible the front and side
- 4 accuracy settings: ± 1 mm, ± 2 mm, ± 4 mm and ± 8 mm
- Energy-saving mode, display illumination can be switched off
- Battery status shown in display
- Switchable acoustic signal
- Bubble for easy alignment
- Automatic shut-off after 15 min.
- Nedo heavy-duty rod clamp and batteries supplied as standard

ACCEPTOR MAXX

MAXXimum detector field

- Detector field with 120 mm length

MAXXimum performance

- Double LED display in front and side
- Illuminated displays

MAXXimum working range

- Working diameter 900 m

MAXXimum precision

- Digital mm display up to ± 52 mm



Nedo ACCEPTOR MAXX

Ref.-No.	430 339
Accuracy	± 1 mm, ± 2 mm, ± 4 mm and ± 8 mm
Working range	\emptyset 900 m (depends on laser)
Length detector field	127 mm
Reception angle	$\pm 45^\circ$
Protection class	IP 67
Operating temperature	-20°C to +60°C
Power supply	2 x 1.5 V type mignon (AA)
Operation duration	approx. 60 h



Nedo laser receivers COMMANDER 2 are equipped with the new, practically indestructible Heavy-Duty rod clamp as a standard.

ACCEPTOR M with tilt compensation

The Nedo **ACCEPTOR M** excavator receiver has a tilt compensation feature to accurately show the position of the excavator blade even when the dipper arm is inclined. The tilt of the dipper arm can be compensated up to an angle of 30°, allowing more precise work.



mm display

Nedo Laser Receiver for Rotating Lasers PRIMUS 2

Nedo COMMANDER 2 with mm display

Extremely robust laser receiver with integrated radio remote control for rotating lasers of the PRIMUS 2 series.

With the mm display, height differences during levelling can be read off directly – without calculation.



MADE IN GERMANY

Features:

- Robust laser receiver incl. radio remote control for PRIMUS 2 rotating lasers
- Large detector field of 70 mm length
- Readout of height difference in mm
- Large illuminated LC displays on the front and back
- Size of directional arrows is proportional to difference in height
- Bright LED display
- 4 accuracy settings: $\pm 0,5$ mm, ± 1 mm, ± 2 mm and ± 4 mm
- Battery status shown in display
- Adjustable volume
- Bubble for easy alignment
- Automatic shut-off after 15 min.
- Protected against splash and dust to IP 66
- Power supply: 3 x 1,5 V (AA)
- Operation duration: up to 100 h
- Supplied with Heavy-Duty rod clamp and batteries as a standard

Technical data:	
Accuracy switchable,	± 0.5 mm, ± 1 mm, ± 2 mm and ± 4 mm
Working range	\emptyset 700 m (depends on laser)
Length of detector field	70 mm
Reception angle	$\pm 50^\circ$
Protection class	IP 66
Operating temperature	-20°C to +50°C
Power supply	3 x 1.5 V batteries (AA) or rechargeable batteries (NiMH)
Operation duration	up to 100 h

Ref.-No. 430 370 COMMANDER 2 HVA

Ref.-No. 430 371 COMMANDER 2 H2N

Ref.-No. 430 374 COMMANDER 2 H2N+

Ref.-No. 430 375 COMMANDER 2 HVA2N

www.nedo.com

Nedo ACCEPTOR M

Sturdy laser receiver with easy-to-view display for use with construction machinery. When used with a rotating laser, the new Nedo **ACCEPTOR M** excavator receiver accurately shows whether the excavator blade is above, at or below the required height. Large, bright LEDs make it easy to view the display from the excavator cab. The switchable tilt compensation accounts for tilting of the dipper arm up to an angle of 30°. In this way the **ACCEPTOR M** reliably and accurately shows the position of the excavator blade in relation to the required height.

Features:

- Robust excavator receiver for all rotating lasers with red laser beam
- Large detector field with a length of 190 mm
- 220° reception angle for reliable reception of the laser beam
- Very sturdy design
- Splashproof and dustproof in accordance with IP 66
- Firmly attached to the dipper arm by means of 12 very strong magnets
- Rubber studs to prevent slipping
- 3 precision levels with resolutions of 4 mm, 8 mm or 12 mm
- Very bright LEDs for easy viewing from the cab
- Tilt compensation up to 30° for greater precision even when the dipper arm is inclined
- Deactivatable signal tone
- Transport case and folding rule included
- Suitable for all rotating lasers with wavelengths from 600 nm to 780 nm



Nedo ACCEPTOR M

Ref.-No.	430 335
Accuracy	± 4 mm, ± 8 mm and ± 12 mm
Working range	\emptyset 1000 m (depends on laser)
Length of detector field	190 mm
Reception angle	220°
Protection class	IP 66
Operating temperature	-10°C to +50°C
Power supply	1 x 1.5 V mono-cell
Operation duration	approx. 45 h



Nedo Facade Construction Adapters

The **Facade Construction Adapters** are fastened to the wall and horizontally aligned with the aid of integrated bubbles. Thanks to the mm graduations provided on the traverses, rotating lasers and laser receivers can be conveniently positioned at the required distance from the wall. The new **Facade Construction Adapters** have been optimally matched to the fully automatic PRIMUS 2 HVA and PRIMUS 2 HVA2N rotating lasers with AutoAlign function and to the COMMANDER 2 laser receiver, and provide in combination with these instruments a professional and complete system for facade construction.

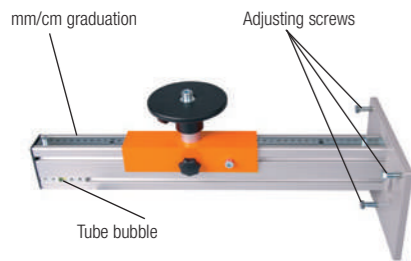

Facade Construction Adapter for PRIMUS 2 Rotating Lasers

Sturdy aluminium **facade construction adapter**. Sliding runner with tripod head and 5/8" connecting thread. Adjusting range approx. 450 mm.

Three adjusting screws allow exact alignment of the **facade construction adapter**.

Ref.-No. 461 046

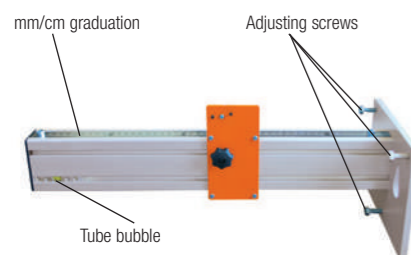

Facade Construction Adapter for COMMANDER 2 Laser Receivers

Sturdy aluminium **facade construction adapter**. Sliding runner for accommodating the COMMANDER 2 laser receiver. Adjusting range approx. 490 mm.

Three adjusting screws allow exact alignment of the **facade construction adapter**.

Ref.-No. 461 056



Mini-Flexi Rod for Facade Construction

The mini-flexi rod allows distances in facade construction to be measured quickly and easily. Measurement range: 65 mm to 280 mm

Ref.-No. 461 048



Nedo Batter Board Holder

On modern construction sites the batter board is increasingly being supplanted by a rotating laser. The laser is, in vertical operation, placed on a **batter board holder** fastened to the batter board by a clamping screw. The **batter board holder** is provided with a turntable allowing rough alignment of the rotating laser.

The laser receiver with the receiver holder is clamped on the opposite side of the batter board. Thanks to the AutoAlign function, the laser plane automatically aligns with the laser receiver in the case of the PRIMUS 2 HVA and PRIMUS 2 HVA2N models. Furthermore, the laser plane is automatically monitored and if necessary corrected by the AutoAlign function.



Batter Board Holder for Rotating Lasers PRIMUS 2

Sturdy aluminium **batter board holder** with four clamping screws. Suitable for use with rotating lasers from the PRIMUS 2 series.

clamping range: 18 - 85 mm

Ref.-No. 461 051

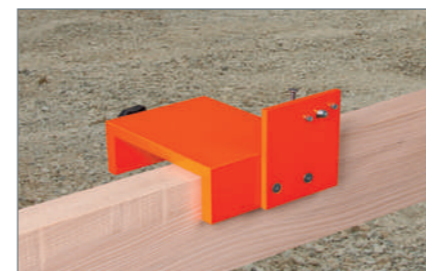

Batter Board Holder for Laser Receiver COMMANDER

Sturdy aluminium **batter board holder** with one clamping screw. Suitable for use with COMMANDER 2 laser receiver.

clamping range: 18 - 90 mm

Ref.-No. 461 055





Nedo Accessories PRIMUS 2



Telescopic Sight

The use of dual-axis slope lasers requires an extremely exact alignment of the laser axes. With the help of the PRIMUS 2 **telescopic sight** with integrated target laser the laser axis can be precisely aligned to the target even if it is a great distance away. The **telescopic sight** can easily be fixed to the PRIMUS 2 without any tools. Suitable for use with the slope lasers PRIMUS 2 H1N+, H2N, H2N+ and HVA2N.

Ref.-No. 461 096



Nedo Multifunctional Base

Rugged base with fine adjustment. Perfect for axis alignment of slope lasers such as Nedo PRIMUS 2 H1N+, H2N, H2N+ and HVA2N.

Ref.-No. 062 579



PRIMUS 2 Battery Box

Battery box for 4 x 1.5 V mono-cells, can be used for all PRIMUS 2 models.

Ref.-No. 461 097



PRIMUS 2 Battery Charger Add-On Kit

Spare battery and charger, can be used for all PRIMUS 2 models.

Ref.-No. 461 098



Nedo Tilt Adapter

With the **tilt adapter**, inclines of up to 90° can be set manually. Quick adjustment with 6 stages and additional fine adjustment. Scale with % and ° units. Ideal for creating slopes or refurbishing roofs.

Incl. circular level, built-in sighting device, 5/8" connecting thread and Quick-Fix system.

Features:

- Accuracy: $\pm 1^\circ$
- Coarse and fine adjustment for quick height settings
- Integrated Quick-Fix system for all lasers in the PRIMUS 2 series
- 5/8" thread for all rotating lasers
- Scale with degree and percent graduations
- Made of high-quality cast aluminium

Ref.-No. 461 047

Nedo Laser Accessories

Outdoor Package for PRIMUS 2 Series

- Aluminium tripod, working range 0.91 m to 1.69 m Ref.-No. 200 225
- Flexi Rod with universal adapter and carrying bag

Ref.-No. 200 350

Accessory Package 1 for PRIMUS 2 Series

- Elevating tripod, working range 0.80 m to 2.76 m Ref.-No. 210 621
- Flexi Rod with universal adapter and carrying bag

Ref.-No. 210 350

Accessory Package 2 for PRIMUS 2 Series

- Elevating tripod, working range 0.78 m to 2.03 m Ref.-No. 210 616
- Flexi Rod with universal adapter and carrying bag

Ref.-No. 210 351



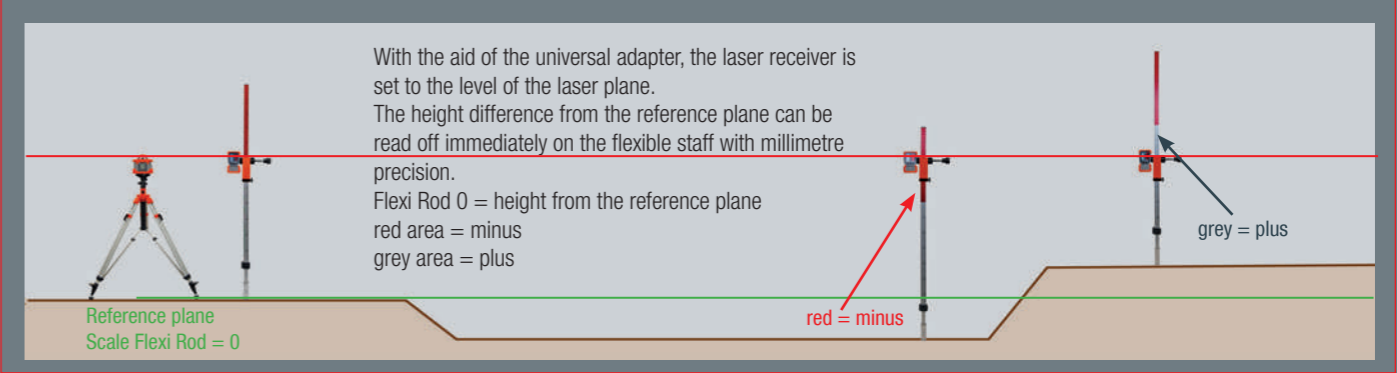

Nedo Laser Accessories

Wall Mount ECO

Robust **wall mount** for line and dot lasers. Can be attached to the wall or to ceiling construction profiles.

Adjustable range: 100 mm

Ref.-No. 461 032-613



Wall Mount »easy«

Robust **wall mount** for all rotating lasers. Can be attached to the wall with two screws.

Adjustable range: 55 mm

Ref.-No. 461 030



Vertical Mount »easy«

For vertical use of the SIRIUS 1 HV or SIRIUS 1 HV green with a tripod.

Ref.-No. 461 031



Wall Mount-S

Robust wall mount for all rotating lasers. Can be attached to the wall or to ceiling construction profiles. Fine adjustment allows heights to be easily reset. Perfect for suspended ceilings. Adjustable range: 150 mm.

The Wall Mount-S can be fixed horizontally to a 5/8" thread tripod. Ideal for exact alignment of the laser in the structural facing sector.

Ref.-No. 461 020



Laser protection glasses

Laser protection glasses for lasers with laser class 3R.

Ref.-No. 460 909



Nedo Flexi Rods

Simply read off the direct reading scale.

When levelling with a rotating laser, the **Flexi Rod** is the ideal accessory for determining differences in heights quickly, exactly and correctly signed.

QualiLine Flexi Rods

Designed to meet the highest standards when it comes to quality and reliability.

Nedo **QualiLine Flexi Rods** are notable for their extremely sturdy aluminium tubes and secure telescope locking mechanism. A bubble level facilitates exact vertical alignment of the rod. The mm graduation is permanently protected by sub-anodised printing against scratches and abrasion. The metal adapter for accommodating the laser receiver has a rugged quick-clamp device made of aluminium.

Carrying bag included

StandardLine Flexi Rods

Reliable quality at a favourable price.

Nedo **StandardLine Flexi Rods** come with a rapid locking system for the telescope. A bubble level facilitates exact vertical alignment of the rod. The metal adapter for accommodating the laser receiver has a screw clamping system.

Carrying bag included

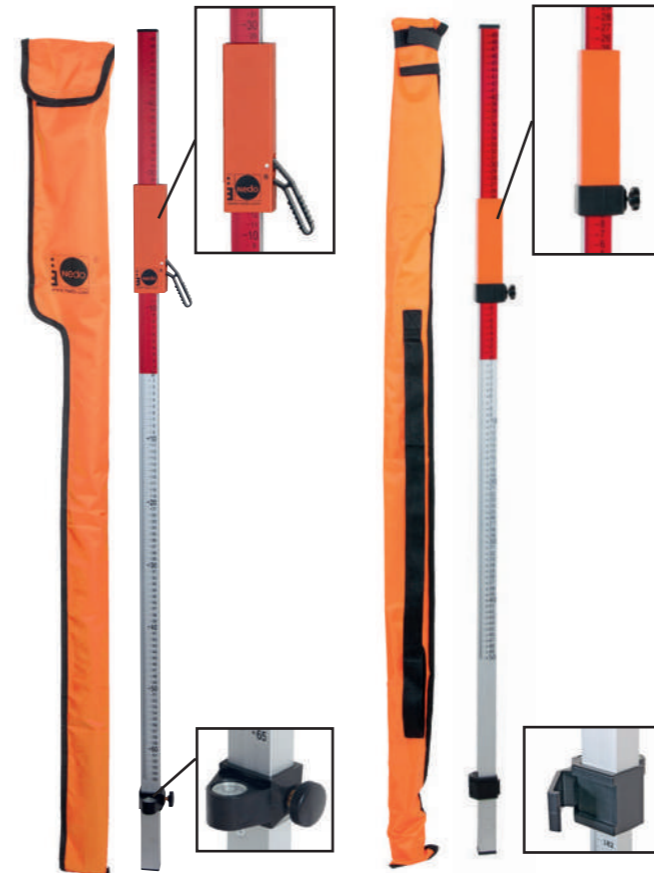

QualiLine Flexi Rod set
Ref.-No. 360 916-622

StandardLine Flexi Rod set
Ref.-No. 360 916-637

Nedo Flexi Rod

Ref.-No.	Type
360 811-637	Flexi Rod StandardLine with circular bubble and case, length 1.36 m to 2.53 m
360 916-637	Flexi Rod set StandardLine Flexi Rod with universal adapter with screw clamp, circular bubble and case, length 1.36 m to 2.53 m
360 916-622	Flexi Rod set QualiLine Flexi Rod with universal adapter with quick clamp, circular bubble and case, length 1.31 m to 2.42 m



Optional Accessories Base plate for casting concrete
Ref.-No. 365 111



The analog display of the Nedo **Laser mEssfix-S** clearly shows the height difference between the zero line of the laser receiver and the ground point.

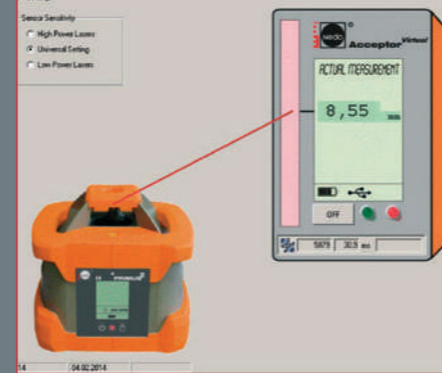

The Nedo **Laser Calibration 2** is distinguished by its intuitive user interface. The accuracy of the rotation laser being tested can be read off directly in mm/m.



Nedo Laser mEssfix-S

Nedo **Laser mEssfix-S** is a robust telescopic measuring stick for determining differences in height with a rotating laser and a laser receiver. Perfect for use in excavation jobs, levelling and civil engineering projects.

Simply attach the laser receiver to the **Laser mEssfix-S** and position the detector in the laser plane by means of telescopic sections. The height of the laser plane can be read off from the analogue display.

Quick, simple and precise.

The universal adapter allows to attach all kinds of laser receivers to the **Laser mEssfix-S**. In order to avoid unintentional changes in the extended length, the telescopes are equipped with a clamping screw to ensure a secure hold. The vertical position is maintained thanks to the circular bubble.

Features:

- Robust telescopic measuring stick with easy-to-read analogue display
- Universal adapter to accommodate all types of laser receivers
- Circular bubble to ensure an exact alignment
- Anodised telescopes, can be fixed with clamping screws
- Easy to handle
- Reliable levelling system for all rotating lasers with receiver
- Supplied with case as a standard
- Made in Switzerland



Nedo Laser mEssfix-S

Ref.-No.	Features	Min. length	Max. length	Incl. case
F 687 511	with universal adapter	1.37 m	5.17 m	yes
F 887 511	with universal adapter	1.70 m	6.83 m	yes

* Laser receiver and rod clamp not included.



Nedo Laser Calibration 2

The **Laser Calibration 2** is a professional, PC-based system for monitoring and adjusting the horizontal laser plane of red and green rotating lasers. It uses state-of-the-art image processing for quick and inexpensive monitoring and adjustment. The system can automatically generate, archive and print out test records. These records can be individually designed and tailored to the needs of the service shop. An easy-to-use Windows interface is provided for operation. Professional service shops will appreciate its highly compact design and encapsulation of the system in a sturdy housing. Nedo **Laser Calibration 2** can be integrated into a computer network, where it is well prepared for future expansion and accessible for remote maintenance by Nedo.

Complete system, including PC, software and hardware.

Features:

- Professional, PC-based system for monitoring and adjusting the horizontal accuracy of rotating lasers
- For red and green lasers
- Measurement principle: state-of-the-art image processing
- Professional adjustment system for service and repair workshops that emphasise cost-effectiveness
- Network-capable
- Remote maintenance by Nedo possible
- Print-outs of personalised test records possible



Personalised test records. Archiving in PDF format.

Nedo Laser Calibration 2

Ref.-No.	461 100
Dimensions	1082 mm x 400 mm x 888 mm
Weight	25.5 kg
Accuracy	± 0.05 mm/m (10")
Resolution	± 0.051 mm/m (2")
Suitable for rotating lasers	laser class 2 ... 3R, 532 - 635 nm



BUILDERS' LEVELS / THEODOLITES

Focus on Precision

Nedo offers an attractive range of optical surveying instruments. In order to meet differing needs in terms of robustness and accuracy, Nedo has three different level series with different magnifications. All Nedo levels have high-quality optical systems with plenty of lightgathering power.

Our electronic theodolites are optionally available with an optical plummet or a laser plummet.

Each Nedo surveying instrument is thoroughly inspected and precisely adjusted before shipment, and each comes with a test report.





The Principles of Optics

The magnification of an optical instrument indicates how much closer a target appears to the user when looking through the instrument compared when looking to the target without instrument. The larger the magnification is chosen, the smaller the field of vision and the light intensity get. The objective aperture also has a great influence on the light intensity. The larger the objective aperture, the better is the light intensity of the object, i.e. the brighter the image.



Automatic Levels

Levelling instruments are used to create a horizontal line of sight in order to determine differences in height. The main components include a telescope with crosshair which can rotate around the vertical axis, a horizontal circle for marking off the angles, and the bubble which helps to keep the instrument in a horizontal position with a tribrach. Automatic levels also feature a compensator mechanism which will adjust the level to an exactly horizontal position within a small working range. The compensators are equipped with a damping system. In practice, air-damped and magnetically damped compensators have become generally accepted. The air-damped compensators are of better quality whereas magnetically damped compensators are more favourably priced.



Theodolites

A theodolite is an instrument used for precise measurements of vertical and horizontal angles. On construction sites, theodolites are further used for making exact alignments, e.g. when foundations are cast and for checking if formwork and facades are perfectly vertical. The precision of a theodolite is given in arcseconds.

Electronic theodolites with digital displays have become generally accepted as they provide easy read-offs.



Selecting the Right Nedo Levelling Instrument

Nedo offers a range of various automatic levelling instruments:

- **F Series:** State-of-the-art builders' levels with powerful optical systems. Sturdy and reliable for tough jobs on construction sites.
- **X Series:** Premium builders' levels that meet the highest quality standards. Protected against dust and jet water as per IP X6.
- **Z Series:** Engineers' levels that meet the highest quality standards. Protected against dust and jet water as per IP X6.

Each Nedo levelling instrument is carefully checked and adjusted before dispatch. All Nedo automatic levels are accompanied by an inspection record as part of the scope of delivery.

Selecting the Right Magnification

As a rule of thumb, the magnification should be the target distance in metres. Levels with a 24x magnification are ideal for applications on the construction site. Levels with a 28x or 32x magnification are used mainly for engineering and surveying purposes.

	Working environment		
	tough	extremely tough	extremely tough / moist environment
Builders' Levels F-Series	✓		
Builders' Levels X-Series	✓	✓	
Engineers' Levels Z-Series	✓	✓	✓



Nedo Builders' Levels F-Series

The **F-levels** feature first-class optics with 24x, 28x or 32x magnification, a top-quality magnetic-damped compensator and a modern design. Just right for use under tough conditions.

Features:

- Automatic builders' level with 24x, 28x or 32x magnification
- Bright optics with large objective aperture
- Sturdy, reliable magnetic-damped compensator
- Rugged metal housing
- High-contrast image
- Inspection record
- Comes with plumb bob, adjusting pin and robust case
- Also available as a set



Nedo Builders' Levels F-Series

	F24	F28	F32
Ref.-No. (horizontal circle gon)	460 777-613	460 795-613	460 797-613
Ref.-No. (horizontal circle degrees)	460 778-613	460 796-613	460 798-613
Ref.-No. Set (horizontal circle gon)	463 105	465 105	466 105
Image	upright	upright	upright
Magnification	24x	28x	32x
Clear objective aperture	30 mm	30 mm	40 mm
Shortest focusing distance	0.6 m	0.6 m	0.6 m
Multiplication factor	100	100	100
Compensator operating range	± 15'	± 15'	± 15'
Setting accuracy	± 0.5"	± 0.3"	± 0.3"
Horizontal circle	400 gon / degrees	400 gon / degrees	400 gon / degrees
Sensitivity of circular bubble	8'/2 mm	8'/2 mm	8'/2 mm
Standard deviation per km double-run levelling	± 2.5 mm	± 2.0 mm	± 1.5 mm
Protection class	IP 54	IP 54	IP 54
Weight	1.26 kg	1.26 kg	1.26 kg
Connecting thread	5/8"	5/8"	5/8"



- Levelling set with F-level consisting of:**
- 5 m levelling staff, clip on bubble and bag No. 345 122-637
 - Aluminium tripod No. 200 215-637

Calibration certificate for Nedo builders' levels

Ref.-No.	399 558 Calibration certificate for builders' levels series F, X and Z
-----------------	---

Nedo Builders' Levels X-Series

Nedo **X-levels** are top-quality builders' levels which meet the very highest demands. These builders' levels feature particularly bright optics, a large objective aperture, a sturdy air-damped compensator and quality workmanship – just right for use under eXtremely tough conditions.

Features:

- Automatic builders' level with 24x and 32x magnification
- Bright optics with large objective aperture
- Rugged metal housing
- Sturdy, reliable air-damped compensator
- High-contrast image
- Inspection record
- Comes with plumb bob, adjusting pin and robust case
- Also available as a set

Nedo Builders' Levels X-Series

	X24	X32
Ref.-No. (horizontal circle gon)	460 759	460 760
Ref.-No. (horizontal circle degrees)	460 759-633	460 760-633
Ref.-No. Set (horizontal circle gon)	464 245	464 325
Image	upright	upright
Magnification	24x	32x
Clear objective aperture	40 mm	40 mm
Shortest focusing distance	0.6 m	0.6 m
Multiplication factor	100	100
Compensator operating range	± 15'	± 15'
Setting accuracy	± 0.5"	± 0.3"
Horizontal circle	400 gon / degrees	400 gon / degrees
Sensitivity of circular bubble	8'/2 mm	8'/2 mm
Standard deviation per km double-run levelling	± 2.0 mm	± 1.0 mm
Protection class	IP 54	IP 54
Weight	1.6 kg	1.6 kg
Connecting thread	5/8"	5/8"



- Levelling set with X-level consisting of:**
- 5 m levelling staff, clip on bubble and bag No. 345 122-637
 - Aluminium tripod No. 200 215-637

Calibration certificate for Nedo builders' levels

Ref.-No.	399 558 Calibration certificate for builders' levels series F, X and Z
-----------------	---



Batter board holder for theodolite
Sturdy aluminium batter board holder with four clamping screws.
Ref.-No. 461 051



Diagonal eyepiece
Designed for measuring steep vertical angles.
With bag.
Ref.-No. 460 813-613



Nedo Engineers' Levels Z-Series

Nedo **Z-Series levels** are premium engineers' levels that meet the most exacting demands. The levels in this series have an especially large aperture to provide plenty of light-gathering power, a rugged, air-damped compensator and a jet-water proof metal housing rated IP X6. Perfect for extreme conditions like dust and rain.

Features:

- Automatic engineers' level with 24x or 32x magnification
- Bright optics with large objective aperture
- Rugged metal housing
- Jet water and dust proof; IP X6
- Large objective aperture: 36 mm
- Sturdy, reliable air-damped compensator
- High-contrast image
- Inspection record
- Comes with plumb bob, adjusting pin and robust case
- Also available as a set



Nedo Engineers' Levels Z-Series

	Z24	Z32
Ref.-No. (horizontal circle gon)	460 756	460 758
Ref.-No. (horizontal circle degrees)	460 756-633	460 758-633
Ref.-No. Set (horizontal circle gon)	465 245	465 325
Image	upright	upright
Magnification	24x	32x
Clear objective aperture	36 mm	36 mm
Shortest focusing distance	0.65 m	0.65 m
Multiplication factor	100	100
Compensator operating range	± 15'	± 15'
Setting accuracy	± 0.5"	± 0.3"
Horizontal circle	400 gon / degrees	400 gon / degrees
Sensitivity of circular bubble	8'/2 mm	8'/2 mm
Standard deviation per km double-run levelling	± 2.0 mm	± 1.0 mm
Protection class	IP X6	IP X6
Weight	1.75 kg	1.75 kg
Connecting thread	5/8"	5/8"



Levelling set with Z-level consisting of:

- 5 m levelling staff, clip on bubble and bag No. 345 122-637
- Aluminium tripod No. 200 215-637

Calibration certificate for Nedo builders' levels

Ref.-No.	399 558 Calibration certificate for builders' levels series F, X and Z
-----------------	---

Nedo ET-5 Electronic Theodolite with Optical Plummet or Laser Plummet

Robust builders' theodolite with digital display and automatic vertical compensator. The Nedo **ET-5** stands out thanks to its precision, reliability and simple and intuitive handling.

Features:

- Bright optics with 30x magnification
- 2 large, easy-to-read LCD illuminated displays
- 2 clearly arranged control panels
- Automatic vertical compensator; Working range ± 3'
- Horizontal circle with right/left function
- Horizontal circle can be set to zero in any position
- Hold function for horizontal circle
- Automatic switch-off after 30 minutes; can be deactivated
- Robust tribrach with 5/8" connecting thread
- Incl. rechargeable batteries, charger, plumb bob, weather protection, tools and robust case
- Available with optical plummet or with laser plummet



Nedo Electronic Theodolite ET-5 with Optical Plummet or Laser Plummet

	ET-5 with optical plummet	ET-5 with laser plummet
Ref.-No.	460 812-613	460 814-613
Magnification	30x	30x
Shortest focusing distance	1.35 m	1.35 m
Clear objective aperture	45 mm	45 mm
Minimum reading	1" or 5"	1" or 5"
Accuracy	5"	5"
Angle units	degrees(0-360) / gon(0-400) / mil (0-6400)	degrees(0-360) / gon(0-400) / mil (0-6400)
Spirit level	30"/2 mm	30"/2 mm
Circular bubble	8'/2 mm	8'/2 mm
Connecting thread of tribrach	5/8" BSW	5/8" BSW
Operating temperature	-20°C to +50°C	-20°C to +50°C
Power supply	4 x 1.5 V AA or rechargeable batteries	4 x 1.5 V AA or rechargeable batteries
Operation duration	batteries 36 h, rechargeable batteries 18 h	batteries 36 h, rechargeable batteries 18 h
Weight	4.7 kg	4.7 kg
Magnification optical plummet	3x	
Accuracy optical plummet	± 0.5 mm/1.5 m	
Laser plummet		<1 mW, laser class 2, 650 nm
Accuracy laser plummet		± 1.5 mm/1.5 m
Protection class	IP 54	IP 54



TRIPODS

Get the Maximum Accuracy out of your Surveying Instrument

The stability of a tripod has great impact on the precision achieved with a levelling instrument, a construction laser, a total station or a 3D laser scanner. Depending on the type of instrument, tripods have to meet different requirements and specifications.

Bearing this in mind, Nedo has developed a unique range of tripods comprising aluminium tripods, elevating tripods, wooden tripods and practical accessories. The latest addition are Carbon Line and Industrial Line elevating tripods which are designed specifically for use with 3D laser scanners.





Standard or Elevating Tripod?

Nedo standard tripods without a crank mechanism are ideal for levelling tasks with builders' levels or horizontal lasers. Nedo elevating tripods are recommended for applications that require an exact adjustment of the construction laser to a certain working height, e.g. in ceiling construction and other installation work. The desired working height, even of heavy-duty rotating lasers, can be adjusted quickly with Nedo elevating tripods.



Aluminium, Wood or Carbon?

Modern construction tripods are made of aluminium. Nedo aluminium tripods are lightweight, extremely robust and rigid. They are suitable for the use of builders' levels, rotating lasers and builders' theodolites. Surveyors however, prefer wooden tripods for high-precision instruments as they feature a better damping behaviour and are less affected by temperature changes than aluminium tripods.



The wooden parts of all Nedo wooden tripods are coated with a high-tech plastic material to protect them against moisture. This ensures that Nedo wooden tripods are extremely weatherproof and robust.



In addition to rigidity, the weight of a tripod plays an important role in the use of mobile 3D laser scanners. Carbon-fibre-reinforced plastic (CFRP) is a modern composite material that combines high rigidity and low weight. That is why users of 3D laser scanners rely on Nedo Carbon Line tripods in mobile applications.

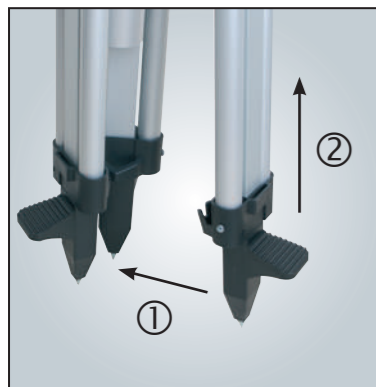

Strapless-Go Leg locking system without a strap

Many Nedo tripods and elevating tripods are equipped with the new Strapless-Go leg locking system without a strap. The tripod legs snap together automatically when they are pushed in. It's quick and convenient. No more troublesome strapping to hold legs in place for transport.

To release the lock, simply pull out the leg with the printed marking. The legs immediately unlock and you can set up the tripod.

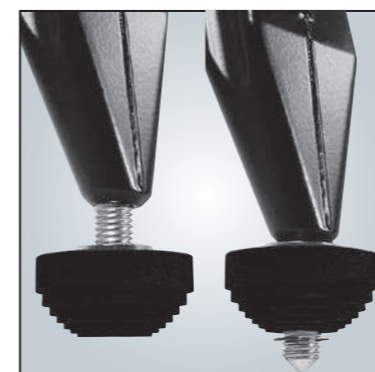
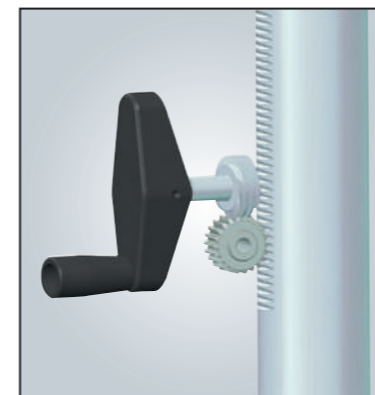
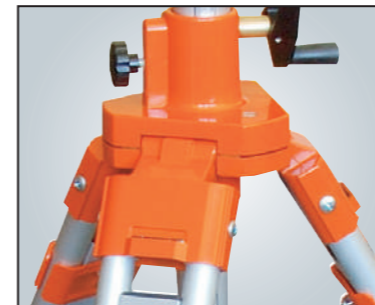

Details which matter

Nedo tripods set standards in terms of stability, reliability and extremely robust design. Furthermore, all Nedo tripods feature the following details which matter on the job:

- **Quick release levers: perfect for the use under tough conditions on the construction site**
- **Brass hinge pins: robust and reliable**
- **Retaining screw with plumb bob hook that folds away to the side: perfect for the use of an optical or a laser plummet**

Nedo tripods for use in interior finishing are equipped with a slip guard that prevents the tripod legs from slipping on slippery floors.

Elevating Tripods with Indirect Gear

A reduction gear in between the crank and the toothed rack allows for maximum convenience to set up even heavy rotating lasers at the desired working height. Furthermore the reduction gear unit prevents any unintended descent of the laser when the locking screw is released.

Combi tripod feet

For work on uneven outdoor terrain activate the steel points by screwing in the rubber balls.

Hide the steel points with the rubber balls when working on smooth or sensitive floors.

Combi tripod feet are available as a retrofit kit for many tripods.

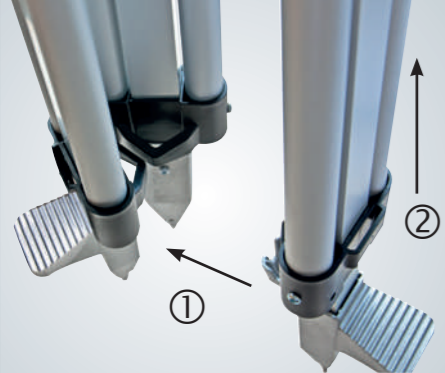

Strapless-Go: leg locking system without a strap
 Many Nedo tripods and elevating tripods are equipped with the new leg locking system without a strap. The tripod legs snap together automatically when they are pushed in. It's quick and convenient. No more troublesome strapping to hold legs in place for transport.
 To release the lock, simply pull out the leg with the printed marking.
 The legs immediately unlock and you can set up the tripod.



Lightweight Aluminium Tripods



Tripod Ref.-No. 200 631

- Min. effective height approx. 0.53 m
- Max. effective height approx. 0.85 m
- Retracted length approx. 0.61 m
- Weight 2.40 kg
- Holding screw: 5/8" thread
- Tripod head flat, Ø 140 mm

Features:

- Aluminium tripod head
- Quick clamp
- Strapless-Go: leg locking system without a strap
- Slip guard

Suitable for:

- Dot and line lasers
- Rotating lasers



Tripod Ref.-No. 200 215-637 (flat head)
Tripod Ref.-No. 200 216-613 (domed head)

- Min. effective height approx. 0.93 m
- Max. effective height approx. 1.54 m
- Retracted length approx. 0.99 m
- Weight 3.55 kg
- Holding screw: 5/8" thread
- Tripod head flat, Ø 140 mm

Features:

- Tripod head and joints made of aluminium
- Quick clamp
- Carrying strap

Suitable for:

- Builders' levels
- Rotating lasers



Tripod Ref.-No. 200 221

- Min. effective height approx. 0.91 m
- Max. effective height approx. 1.69 m
- Retracted length approx. 1.06 m
- Weight 3.41 kg
- Holding screw: 5/8" thread
- Tripod head flat, Ø 140 mm

Features:

- Aluminium tripod head
- Quick clamp
- Strapless-Go: leg locking system without a strap
- Slip guard
- In accordance with ISO 12858-2-LF

Suitable for:

- Builders' levels
- Rotating lasers

Medium-Duty Aluminium Tripods



Ref.-No. 200 412-614 (with slip guard)
Ref.-No. 200 412 (without slip guard)

- Min. effective height approx. 0.78 m
- Max. effective height approx. 1.18 m
- Retracted length approx. 0.82 m
- Weight 4.00 kg
- Holding screw: 5/8" thread
- Tripod head flat, Ø 140 mm

Features:

- Tripod head and joints made of aluminium
- Quick clamp
- Slip guard (Tripod Ref.-No. 200 412-614)

Suitable for:

- Dot and line lasers
- Rotating lasers
- Pipe lasers



Tripod Ref.-No. 200 225

- Min. effective height approx. 0.91 m
- Max. effective height approx. 1.69 m
- Retracted length approx. 1.06 m
- Weight 3.57 kg
- Holding screw: 5/8" thread
- Tripod head flat, Ø 140 mm

Features:

- Aluminium tripod head
- Quick clamp
- Carrying strap
- Slip guard
- Strapless-Go: leg locking system without a strap
- In accordance with ISO 12858-2-LF

Suitable for:

- Builders' levels
- Rotating lasers
- Theodolites



Tripod Ref.-No. 200 203

- Min. effective height approx. 1.00 m
- Max. effective height approx. 1.71 m
- Retracted length approx. 1.07 m
- Weight 4.25 kg
- Holding screw: 5/8" thread
- Tripod head flat, Ø 168 mm

Features:

- Tripod head and joints made of aluminium
- Large, round tripod head
- Quick clamp
- Carrying strap
- Strapless-Go: leg locking system without a strap
- In accordance with ISO 12858-2-LF

Suitable for:

- Builders' levels
- Rotating lasers
- Theodolites



Tripod Ref.-No. 200 250

- Min. effective height approx. 1.01 m
- Max. effective height approx. 1.63 m
- Retracted length approx. 1.07 m
- Weight 4.60 kg
- Holding screw: 5/8" thread
- Tripod head flat, Ø 154 mm

Features:

- Tripod head and joints made of aluminium
- Quick clamp
- Carrying strap

Suitable for:

- Builders' levels
- Rotating lasers
- Theodolites



Heavy-Duty Aluminium Tripods



Tripod Ref.-No. 200 200

- Min. effective height approx. 1.08 m
- Max. effective height approx. 1.72 m
- Retracted length approx. 1.14 m
- Weight approx. 5.00 kg
- Holding screw: 5/8" thread
- Tripod head flat, Ø 140 mm

Features:

- Tripod head and joints made of aluminium
- Quick clamp
- In accordance with ISO 12858-2-LF

Suitable for:

- Builders' levels
- Rotating lasers
- Theodolites



Tripod Ref.-No. 200 233

- Min. effective height approx. 1.02 m
- Max. effective height approx. 1.72 m
- Retracted length approx. 1.10 m
- Weight approx. 4.70 kg
- Holding screw: 5/8" thread
- Tripod head flat, Ø 140 mm

Features:

- Tripod head and joints made of aluminium
- Wing nut clamp
- Strapless-Go: leg locking system without a strap
- In accordance with ISO 12858-2-LF

Suitable for:

- Builders' levels
- Rotating lasers
- Theodolites



Tripod Ref.-No. 200 312

- Min. effective height approx. 1.02 m
- Max. effective height approx. 1.71 m
- Retracted length approx. 1.09 m
- Weight approx. 4.30 kg
- Holding screw: 5/8" thread
- Tripod head domed, Ø 140 mm

Features:

- Tripod head and joints made of aluminium
- Wing nut clamp
- Domed head
- Strapless-Go leg locking system without a strap
- In accordance with ISO 12858-2-LS

Suitable for:

- Builders' levels
- Rotating lasers



Tripod Ref.-No. 200 204

- Min. effective height approx. 1.02 m
- Max. effective height approx. 1.72 m
- Retracted length approx. 1.10 m
- Holding screw: 5/8" thread
- Weight approx. 5.20 kg
- Tripod head flat, Ø 167 mm

Features:

- Tripod head and joints made of aluminium
- Large, round tripod head
- Quick clamp
- Snap Cap
- Carrying strap
- In accordance with ISO 12858-2-H

Suitable for:

- Builders' levels
- Theodolites
- Total stations
- Rotating lasers

Lightweight Elevating Tripods



Tripod Ref.-No. 210 619-613

- Min. effective height approx. 0.57 m
- Max. effective height approx. 1.66 m
- Retracted length approx. 0.60 m
- Holding screw: Interchangeable tripod head with 1/4" and 5/8" thread
- Weight approx. 1.65 kg
- Adjustable column range 300 mm

Features:

- Quick clamp
- Slip guard
- Circular bubble in tripod head
- Carrying bag
- Interchangeable tripod head with 1/4" and 5/8" thread

Suitable for:

- Dot and line lasers
- Lightweight rotating lasers



Tripod Ref.-No. 210 642-616

- Min. effective height approx. 0.59 m
- Max. effective height approx. 1.66 m
- Retracted length approx. 0.64 m
- Weight approx. 1.90 kg
- Holding screw: 1/4" thread
- Adjustable column range 260 mm

Features:

- Quick clamp
- Slip guard
- Tilting head
- Spirit level on tilting head
- Carrying bag

Suitable for:

- Dot and line lasers
- Laser distance meters



Tripod Ref.-No. 210 618

- Min. effective height approx. 0.60 m
- Max. effective height approx. 1.51 m
- Retracted length approx. 0.80 m
- Holding screw: 5/8" thread
- Weight approx. 4.50 kg
- Tripod plate, Ø 110 mm
- Telescopic section 1-fold
- Adjustable column range 414 mm

Features:

- Indirect gear
- Quick clamp
- Slip guard
- Circular bubble
- Tripod head and joints made of aluminium
- mm graduation on telescopic tube

Suitable for:

- Rotating lasers

The crank of elevating tripods with indirect gear moves the height adjustable column via a reduction gear unit. This allows the desired height to be set precisely even with heavy-duty lasers. Furthermore, the reduction gear unit prevents any unintentional descent of the laser when the locking screw is opened. The indirect gear is a particularly convenient solution, especially when using heavy-duty rotating lasers.



Combi Tripod Feet

For work on uneven outdoor terrain activate the steel points by screwing in the rubber balls (fig. A). Hide the steel points with the rubber balls when working on smooth or sensitive floors (fig. B).

Ref.-No. 660 121

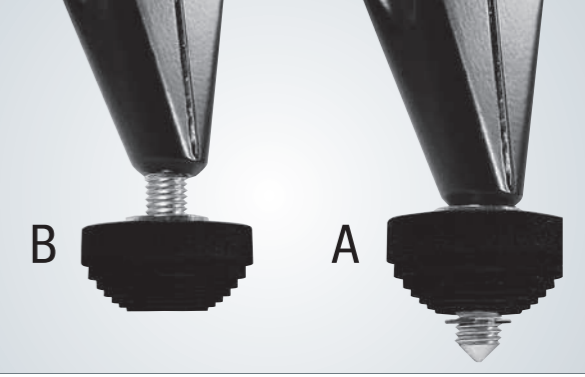

Medium-Duty Elevating Tripods



Tripod Ref.-No. 210 614

- Min. effective height approx. 0.74 m
- Max. effective height approx. 1.73 m
- Retracted length approx. 0.88 m
- Holding screw: 5/8" thread
- Weight approx. 5.20 kg
- Tripod plate, Ø 110 mm
- Telescopic section 1-fold
- Adjustable column range 545 mm

Features:

- Indirect gear
- Quick clamp
- Slip guard
- Circular bubble
- Tripod head and joints made of aluminium
- mm graduation on telescopic tube

Suitable for:

- Rotating lasers



Tripod Ref.-No. 210 616

- Min. effective height approx. 0.78 m
- Max. effective height approx. 2.03 m
- Retracted length approx. 1.02 m
- Holding screw: 5/8" thread
- Weight approx. 5.10 kg
- Tripod plate, Ø 110 mm
- Telescopic section 1-fold
- Adjustable column range 545 mm

Features:

- Indirect gear
- Quick clamp
- Slip guard
- Circular bubble
- Tripod head and joints made of aluminium
- mm graduation on telescopic tube
- Strapless-Go leg locking system without a strap

Suitable for:

- Rotating lasers



Tripod Ref.-No. 210 621

- Min. effective height approx. 0.80 m
- Max. effective height approx. 2.76 m
- Retracted length approx. 1.06 m
- Weight approx. 5.32 kg
- Tripod plate, Ø 110 mm
- Telescopic section 2-fold
- Adjustable column range 580/642 mm

Features:

- Direct gear
- Quick clamp
- Slip guard, circular bubble
- Tripod head and joints made of aluminium
- mm graduation on telescopic tube
- Double telescope
- Strapless-Go leg locking system without a strap

Suitable for:

- Rotating lasers

Heavy-Duty Elevating Tripods



Tripod Ref.-No. 210 676

- Min. effective height approx. 0.90 m
- Max. effective height approx. 2.36 m
- Retracted length approx. 1.21 m
- Weight approx. 5.74 kg
- Tripod plate, Ø 110 mm
- Holding screw: 5/8" thread
- Telescopic section 1-fold
- Adjustable column range 545 mm

Features:

- Indirect gear
- Quick clamp
- Slip guard
- Circular bubble
- Tripod head and joints made of aluminium
- mm graduation on telescopic tube
- Strapless-Go leg locking system without a strap

Suitable for:

- Rotating lasers
- Heavy-duty rotating lasers



Tripod Ref.-No. 210 675

- Min. effective height approx. 0.80 m
- Max. effective height approx. 2.40 m
- Retracted length approx. 1.04 m
- Weight approx. 6.60 kg
- Tripod plate, Ø 110 mm
- Holding screw: 5/8" thread
- Telescopic section 2-fold
- Adjustable column range 490/520 m

Features:

- Double telescope
- Indirect gear
- Quick clamp
- Slip guard
- Circular bubble
- Tripod head and joints made of aluminium
- mm graduation on telescopic tube
- Accessory: Combi tripod feet

Suitable for:

- Rotating lasers
- Heavy-duty rotating lasers



Tripod Ref.-No. 210 678

- Min. effective height approx. 1.01 m
- Max. effective height approx. 2.94 m
- Retracted length approx. 1.32 m
- Weight approx. 7.44 kg
- Tripod plate, Ø 110 mm
- Holding screw: 5/8" thread
- Telescopic section 2-fold
- Adjustable column range 490/520 mm

Features:

- Double telescope
- Indirect gear
- Reinforced telescopes
- Quick clamp
- Slip guard
- Circular bubble
- Tripod head and joints made of aluminium
- mm graduation on telescopic tube
- Accessory: Combi tripod feet

Suitable for:

- Rotating lasers
- Heavy-duty rotating lasers

Additional leg struts give the elevating tripods extra strength, making them suitable for use with heavy-duty lasers or for work at great heights, such as in ceiling construction. In addition, leg struts permit the use of tripods with castors. In this way tripods and instruments can be quickly and easily moved to the place of deployment.

Ref.-No. 660110



Heavy-Duty Elevating Tripods with Additional Leg Struts



Tripod Ref.-No. 210 680

- Min. effective height approx. 0.85 m
- Max. effective height approx. 3.02 m
- Retracted length approx. 1.32 m
- Holding screw: 5/8" thread
- Weight approx. 8.75 kg
- Tripod plate, Ø 110 mm
- Telescopic section 2-fold
- Adjustable column range 600/590 mm

Features:

- Double telescope
- Indirect gear
- Reinforced telescopes
- Additional leg struts
- Quick clamp
- Circular bubble
- Tripod head and joints made of aluminium
- Combi tripod feet
- mm graduation on telescopic tube
- Accessory: Combi tripod feet
- Accessory: Tripod castor set

Suitable for:

- Rotating lasers
- Heavy-duty rotating lasers
- Laser Scanners



Tripod Ref.-No. 210 442

- Min. effective height approx. 1.77 m
- Max. effective height approx. 4.00 m
- Retracted length approx. 1.87 m
- Holding screw: 5/8" thread
- Weight approx. 11.20 kg
- Tripod plate, Ø 110 mm
- Telescopic section 2-fold
- Adjustable column range 600/590 mm

Features:

- Double telescope
- Indirect gear
- Reinforced telescopes
- Additional leg struts
- Dual clamp
- Circular bubble
- Tripod head and joints made of aluminium
- mm graduation on telescopic tube
- Accessory: Combi tripod feet
- Accessory: Tripod castor set

Suitable for:

- Rotating lasers
- Heavy-duty rotating lasers
- Laser Scanners



Tripods for Machine Control Applications

The sturdy design of the Jumbo tripod allows vibration-free use of the machine control laser, even in windy conditions. The large working height ensures that the laser beam does not lie in the shadow of construction vehicles or other obstacles. The indirect gear unit can easily move lasers to the required working height, even if they are heavy.

The Nedo Jumbo Tripod: the elevating tripod for heavy-duty machine control lasers.

Features:

- Indirect gear
- Reinforced telescopes
- Additional leg struts
- Twist proof elevating column with centric clamp
- Circular bubble
- Quick clamp
- Slip guard
- mm graduation on telescopic tube
- Extra large tripod head made of aluminium

Tripod Ref.-No. 210 530

- Min. effective height approx. 1.18 m
- Max. effective height approx. 3.10 m
- Retracted length approx. 1.51 m
- Holding screw: 5/8" thread
- Weight approx. 14.6 kg
- Tripod plate, Ø 167 mm
- Adjust. column range 908 mm

Tripod Ref.-No. 210 540

- Min. effective height approx. 1.73 m
- Max. effective height approx. 4.01 m
- Retracted length approx. 1.94 m
- Holding screw: 5/8" thread
- Weight approx. 17.2 kg
- Tripod plate, Ø 167 mm
- Adjust. column range 908 mm

Set of Rubber Joints

Set consisting of 3 rubber joints. The rubber-covered underside ensures stability and prevents damage to sensitive floors.

Ref.-No. 660 010

Suitable for tripods:

200 100, 200 200, 200 204, 200 412, 200 511, 210 442, 210 530, 210 540, 210 675, 210 710



Large tripod head with 140 mm diameter and 5/8" connection thread.
The slip guard, with three settings, keeps the tripod legs from sliding away on smooth surfaces.



Nedo Fix-it

The new versatile heavy-duty column clamp for construction lasers and instruments.

The ingeniously designed **Fix-it** can securely mount rotating lasers and instruments at countless places in buildings and on construction sites, ensuring a high level of stability.

Fix-it can be attached to pillars, masonry, wall tops or wall formwork using a screw clamp or tie rod. It can be bolted to scaffolding or steel supports and structures or strapped to pillars, beams or posts.

The movable wings made of steel, guarantee secure anchoring on level surfaces or around corners on pillars and beams. The integrated V-shaped mount can be firmly attached to round supports. The attachment possibilities are almost unlimited.

Fix-it features a turnable aluminium mounting plate with a 5/8" connection thread which works with all construction lasers and surveying instruments or any other surveying instruments.

The working height can easily be adjusted with an indirect gear unit like that on an elevating tripod. At the bottom of the elevating column there is a 5/8" internal thread for attachment of a Nedo laser bail (Ref. no. 660131). This allows operation of a rotation laser near the floor.

Nedo **Fix-it** is the new versatile, heavy-duty column clamp for construction lasers and instruments with almost unlimited attachment possibilities. It is secure, easy-to-use and extremely robust.

Perfect for:

- Bricklaying
- Reinforced concrete construction
- Metalworking
- Carpentry and
- All other building trades

Nedo Fix-it

Ref.-No.	461 025
Height adjustment	538 mm, Ø column 45 mm
Mounting plate	Ø 110 mm with 5/8" connection thread
Weight	4.7 kg
Crank drive	indirect
Wings	movable
Arm length	240 mm

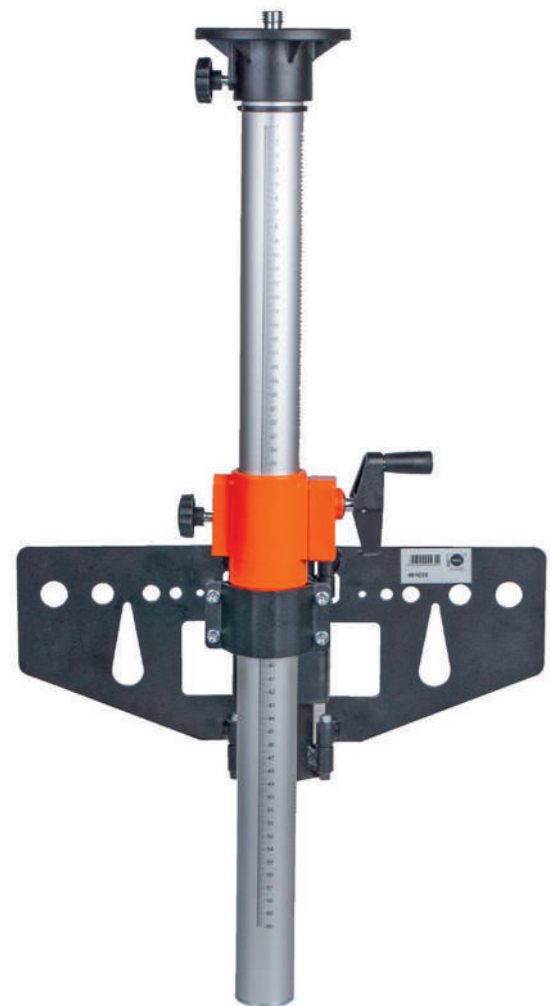

carbon line Carbon Tripod for Laser Scanners

The new Nedo **Carbon Line tripod** was designed specifically for use with 3D laser scanners. Its high-quality tubular sections made of carbon-fiber-reinforced polymer (CFRP) make it especially light and at the same time extremely rigid. The legs of the **Carbon Line tripod** pull out in four sections, giving it a working area from 0.54 m to 1.65 m with a transport length of only 0.60 m.

An adjustable slip guard keeps the tripod legs from sliding away on smooth surfaces. Combi tripod feet allow use of the tripod on sensitive indoor floors as well as outdoors.

The Nedo **Carbon Line tripod** has a large, removable tripod head with a diameter of 140 mm for secure mounting of instruments with a 5/8" connection thread. The standard equipment also includes a smaller top plate for instruments with a 3/8" connection thread. A padded carrying bag is included.



Features:

- Extremely light and robust tripod made of CFRP
- 4-section tripod legs
- Combi tripod feet
- Large top plate, 140 mm diameter, with 5/8" connection thread
- Small top plate, 74 mm diameter, with 3/8" connection thread
- Interchangeable head insert with 3/8" and 5/8" connection thread
- Maximum load
- Spirit level
- Adjustable slip guard
- Two tripod legs with softgrip

Tripod Ref.-No. 200 700

- Min. effective height approx. 0.54 m
- Max. effective height approx. 1.65 m
- Retracted length approx. 0.59 m
- Weight approx. 2.68 kg
- Maximum payload: 30 kg



A padded carrying bag, adapter plate with 3/8" connection thread, adapter plate with 5/8" connection thread and three hex keys are supplied as standard.

Tripod Dolly

Sturdy tripod dolly with lockable wheels.
Ref.-No. 660 035





Tripod bag for Industrial Line tripod for laser scanners
Length: 1350 mm
Ø: 250 mm

Ref.-No. 655 115-613



industrial line

Special Tripod for Laser Scanners

Unlike rotating lasers which are set up once a day and which remain unchanged in that position all day long, laser scanners require elevating tripods that allow to easily lift and lower heavy-duty laser scanners continuously. When working with laser scanners, elevating tripods have to cope with a higher load applied which results in more wear and tear especially in the gear unit. Industrial Line is a new series of tripods perfectly adjusted to meet the special requirements of laser scanners or heavy-duty instruments.

Features:

- Indirect gear to easily lift and lower heavy instruments
- Reinforced gear unit for extra durability and less wear and tear
- Twist proof elevating column with centric clamp
- Tripod legs made of strong aluminium profiles and leg struts for extra stability
- Combi shoes for all terrain use

industrial line

Elevating Tripod for Laser Scanners

Tripod Ref.-No. 210 700:

- Min. effective height approx. 1.13 m
- Max. effective height approx. 2.76 m
- Retracted length approx. 1.28 m
- Weight approx. 9.3 kg
- Holding screw: 5/8" thread
- Tripod plat, Ø 110 mm
- Tripod head and joints made of aluminium
- Adjustable column range 910 mm
- mm graduation on telescopic tube



Circular level for simple alignment, even with an extended tripod



industrial line

Two Way Tripod

Nedo **Industrial Line elevating tripod** is designed especially for the use of 3D laser scanners. The laser scanner can be mounted either at the top or at the bottom of the elevating column ensuring maximum flexibility. When mounted at the top, the laser scanner can be easily lifted to the desired working height. The indirect gear unit allows for maximum convenience. For stability reasons, the maximum working height is limited to 4 m. For shaft applications, the column can be turned and the laser scanner mounted at the bottom of the elevating column and inserted from above the shaft cover into the shaft compartment. The toothed rack extends to almost any length. Additional rack elements are inserted into the elevating head and securely connected to the previously inserted toothed rack element with the aid of an innovative locking device. For even more comfort, the laser scanner can be lifted with a cordless power drill. A proper screw bit to replace the crank is supplied as a standard. Needless to say that the **Industrial Line elevating tripod** is equipped with a twist proof elevating column with centric clamping and combi tripod shoes for all-terrain use.

Tripod Ref.-No. 210 710:

- Min. effective height approx. 1.12 m
- Max. effective height approx. 5.00 m
- Depth of shaft approx. 4.00 m
- Retracted length approx. 1.21 m
- Holding screw: 5/8" thread
- Tripod adapter: 3/8" thread
- Weight approx. 8.9 kg
- Tripod plate flat, Ø 110 mm
- Tripod head and joints made of aluminium
- Use of the laser scanner above and below the elevating tripod
- mm graduation on telescopic tube
- Twist proof elevating column with centric clamp
- Suitable for shafts with a diameter of 205 cm maximum



Scope of delivery:

Two way elevating tripod incl. basic gear column, 4 rack elements 1 m each in a carrying bag, 5 mm allen key, magnetic bit holder for cordless screwdriver, hand crank with magnetic bit holder, combi tripod feet and tripod adapter 3/8"



Video Industrial Line elevating tripod



Accessories for Industrial Line Two Way Tripod

Adapters for Laser Scanners

Depending on the weight, overhead mounting of a 3D laser scanner on a two way tripod with a 5/8" socket may be difficult. To make this easier, adapters can be supplied as optional accessories for various laser scanners. They permit safe and easy attachment to the tripod.

Nedo Adapters for Laser Scanners

Ref.-No.	461 100
660 040	Holding screw: 3/8" and 5/8" thread Adapter for Faro Focus 3D S series and M series
660 041	Adapter for Leica HDS6200, HDS6100 and HDS7000 as well as Zoller and Fröhlich Imager 5010
660 042	Adapter for Leica Scanstation P20, P30 and P40 as well as Zoller and Fröhlich Imager 5016
660 043	Adapter for TRIMBLE TX8

Video Adaptors for Laser Scanners for Industrial Line elevating tripods



Elevating tripod

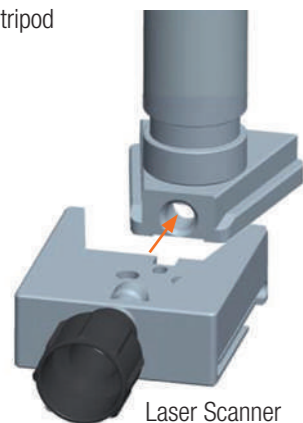

Laser Scanner



Tripod Dolly

Sturdy **tripod dolly** with large steerable and lockable wheels. The points of the tripod are placed in the recesses provided and the feet are secured with a flexible strap. Easy, safe and convenient.

The **tripod dolly** has only two shanks, allowing it to be maneuvered through narrow doors and providing easy access to a laser scanner. For shaft applications the shaft diameter shall not exceed 95 cm. The **dolly** can be folded up to save space in transport.

Ref.-No. 660 030



Accessories for Industrial Line Two Way Tripods

3/8" Tripod Adapter

Tripod adapter made of metal.

Order information:

- Ref.-No. 061 837 Adapter for 5/8" thread to 3/8" thread (suitable for Faro Focus 3D, Leica BLK 360 and Trimble TX5)

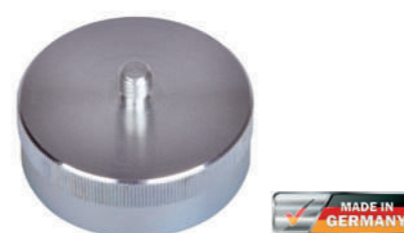

Extension Column

Extra extension column, 1m for Nedo two way tripod Ref.-No. 210 710.

Ref.-No. 660 020



Prisms-Adapter

Adapter with Leica tip. For attachment of a Leica-compatible prism. Perfect for quick calibration of a 3D scanner using a total station.

Ref.-No. 660 050



Nedo wooden tripods are made of carefully selected ash wood. All wooden parts are sealed with a high-tech plastic material that keeps moisture out. This ensures that there is no swelling, shrinking or splintering of wood and it makes Nedo wooden tripods extremely robust and weatherproof. Nedo wooden tripods are more durable than tripods with regular lacquering.

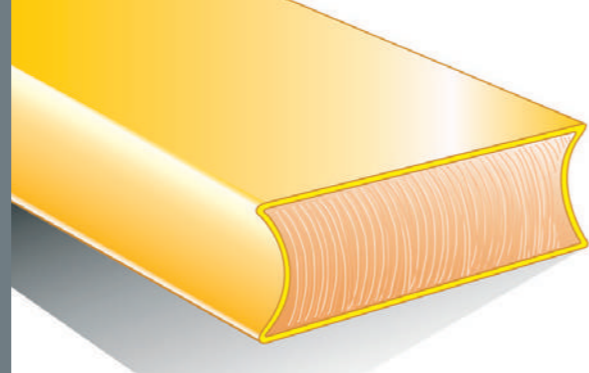

When precise measurements are critical.

Tripods are subjected to different stresses depending on how they are used. Robotic Total Stations, for example, generate large torsion forces through acceleration and braking that must be absorbed. A study carried out by the Faculty of Geodesy at the University of Karlsruhe has shown that heavy wooden tripods made by Nedo can achieve the most accurate measurement results. The test series included heavy-duty wooden tripods and wood-fiberglass tripods from various manufacturers.

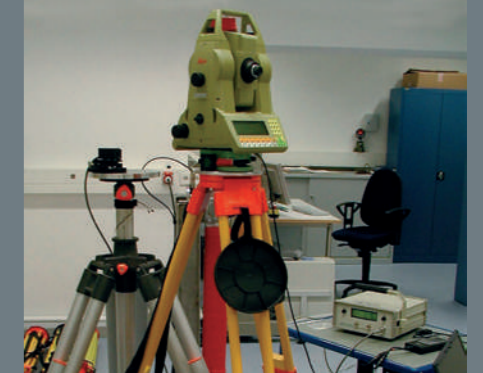

Medium-Duty Wooden Tripods



Tripod Ref.-No. 200 100

- Min. effective height approx. 1.02 m
- Max. effective height approx. 1.65 m
- Retracted length approx. 1.09 m
- Holding screw: 5/8" thread
- Weight approx. 5.40 kg
- Tripod head flat, Ø 140 mm

Features:

- Quick clamp
- Tripod head and joints made of aluminium
- Plastic-coated tripod legs
- Carrying strap
- In accordance with ISO 12858-2-LF

Suitable for:

- Digital levels
- Builders' levels
- Theodolites
- Total stations



Tripod Ref.-No. 200 133

- Min. effective height approx. 1.02 m
- Max. effective height approx. 1.67 m
- Retracted length approx. 1.09 m
- Holding screw: 5/8" thread
- Weight approx. 5.10 kg
- Tripod head flat, Ø 140 mm

Features:

- Wing nut clamp
- Tripod head and joints made of aluminium
- Plastic-coated tripod legs
- Carrying strap
- Strapless-Go: leg locking system without a strap
- In accordance with ISO 12858-2-LF

Suitable for:

- Digital levels
- Builders' levels
- Theodolites
- Total stations



Tripod Ref.-No. 200 530

- Min. effective height approx. 1.02 m
- Max. effective height approx. 1.67 m
- Retracted length approx. 1.09 m
- Holding screw: 5/8" thread
- Weight approx. 5.80 kg
- Tripod head flat, Ø 167 mm

Features:

- Large, round tripod head
- Wing nut clamp
- Plastic-coated tripod legs
- Tripod head and joints made of aluminium
- Snap Cap
- Carrying strap
- Strapless-Go: leg locking system without a strap
- In accordance with ISO 12858-2-LF

Suitable for:

- Digital levels
- Builders' levels
- Theodolites
- Total stations



Tripod Ref.-No. 200 513

- Min. effective height approx. 1.02 m
- Max. effective height approx. 1.69 m
- Retracted length approx. 1.10 m
- Holding screw: 5/8" thread
- Weight approx. 7.60 kg
- Tripod plate flat, Ø 167 mm

Features:

- Large, round tripod head
- Tripod head and joints made of aluminium
- Plastic-coated tripod legs
- Quick clamp
- Snap Cap
- Carrying strap
- Strapless-Go: leg locking system without a strap
- In accordance with ISO 12858-2-H

Suitable for:

- Robotic total stations
- Total stations
- Digital levels
- Theodolites
- Heavy-duty rotating lasers



Tripod Ref.-No. 200 533

- Min. effective height approx. 1.05 m
- Max. effective height approx. 1.70 m
- Retracted length approx. 1.12 m
- Holding screw: 5/8" thread
- Weight approx. 7.10 kg
- Tripod plate flat, Ø 167 mm

Features:

- Large, round tripod head
- Tripod head and joints made of aluminium
- Plastic-coated tripod legs
- Wing nut clamp
- Snap Cap
- Carrying strap
- Strapless-Go: leg locking system without a strap
- In accordance with ISO 12858-2-H

Suitable for:

- Robotic total stations
- Total stations
- Digital levels
- Theodolites
- Heavy-duty rotating lasers



Tripod Ref.-No. 200 532

- Min. effective height approx. 1.05 m
- Max. effective height approx. 1.70 m
- Retracted length approx. 1.12 m
- Holding screw: 5/8" thread
- Weight approx. 7.10 kg
- Tripod plate flat, Ø 167 mm

Features:

- Large, round tripod head
- Tripod head and joints made of aluminium
- Plastic-coated tripod legs
- Quick clamp
- Wing nut clamp
- Snap Cap
- Carrying strap
- Strapless-Go: leg locking system without a strap
- In accordance with ISO 12858-2-H

Suitable for:

- Robotic total stations
- Total stations
- Digital levels
- Theodolites
- Heavy-duty rotating lasers



In retrofitting, the Quick-Fix adapter plate is attached to the tripod with the clamping screw, and the round Quick-Fix adapter is attached to the instrument.



Heavy-Duty Wooden Tripods

Nedo Wooden Tripod with Fixed Tripod Legs

Tripod Ref.-No. 200 511

- Min. effective height approx. 1.53 m
- Max. effective height approx. 1.53 m
- Retracted length approx. 1.61 m
- Holding screw: 5/8" thread
- Weight approx. 6.70 kg
- Tripod plate flat, Ø 167 mm

Features:

- Large, round tripod head
- Plastic-coated tripod legs
- Fixed tripod legs
- Snap Cap

Suitable for:

- Robotic Totalstation
- Digitalnivellier
- Theodolit
- Tachymeter



Accessories for Tripods

Nedo Quick-Fix

Quick-Fix is an innovative rapid locking system for attaching a level or laser to a tripod. The instrument can be fixed to the tripod without the need for a 5/8" clamping screw. No damage from falling, no wasted time. **Quick-Fix** fits any tripod with a 5/8" mounting thread.

Ref.-No. 572 111

Simple

With **Quick-Fix** the instrument can be securely fixed to the tripod and quickly taken off. You just move a lever.

Secure

Expensive damage from falling is prevented.

Fast

Place the instrument on the adapter plate, move the lever, done.



Accessories for Tripods

Extra Large Tripod Head

Metal tripod head, extra large version, Ø 167 mm

Order information:

- Ref.-No. 660 150 fits Nedo elevating tripods with a column diameter of 28 mm
- Ref.-No. 660 160 fits Nedo elevating tripods with a column diameter of 36 mm
- Ref.-No. 660 170 fits Nedo elevating tripods with a column diameter of 45 mm

Tripod Adapter

Tripod adapter made of metal.

Order information:

- Ref.-No. 059 220 Adapter for 5/8" thread to 1/4" thread
- Ref.-No. 061 837 Adapter for 5/8" thread to 1/4" thread



Laser Bail

Ideal when laying screed and all other professionals who use their construction laser close to the floor. The **laser bail** is fixed to the end of the crank column. The rotating laser can be operated near the floor and the height can be easily adjusted using the crank mechanism. **Laser bail** fits any Nedo elevating tripod.

Ref.-No. 660 131



Nedo Laser Bail
Comfortable working near the floor





Accessories for Tripods



Tripod Bag

Length: 1300 mm
 Ø: 220 mm

Ref.-No. 655 112-613



Ballast Bag

Ballast bag for weighing down a tripod. The bag is attached to a tripod leg with two fixing straps.
 Set consisting of 3 ballast bags and 6 fixing straps.

Ref.-No. 660 011



Tripod Star

The Nedo tripod star (Ø 1 m) is especially useful for securing tripods in indoor work on smooth floors.

Ref.-No. 665 111

Accessories for Tripods

Combi Tripod Feet

For work on uneven outdoor terrain activate the steel points by screwing in the rubber balls (fig. A). Hide the steel points with the rubber balls when working on smooth or sensitive floors (fig. B).

Ref.-No. 660 121

Suitable for tripods:

200 100, 200 133, 200 200, 200 204, 200 233, 200 312, 200 412, 200 412-614, 200 511, 200 513, 200 530, 200 532, 200 533, 210 442, 210 530, 210 540, 210 675, 210 676, 210 678, 210 680, 210 700, 210 710

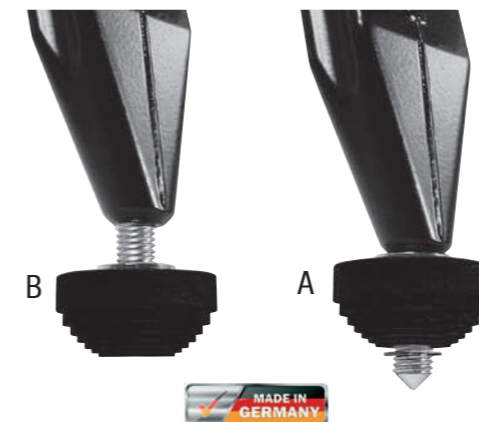

Tripod Castors Set

Accessory for heavy-duty elevating tripods with leg struts. Simply remove the tripod points and replace them with the tripod castors. Each castor is equipped with a brake. The set consists of three tripod castors.

Thread: M10

Ref.-No. 660 110

Suitable for tripods:
 210 680, 210 442



Elevating Head

To be mounted to any tripod with flat head. The tripod can then be used as an elevating tripod.

Features:

- Connecting thread: 5/8"
- Adjustable range: 105 mm

Ref.-No. 570 112





MEASURING TOOLS

Precise Measurement of Lengths, distances and Angles

Nedo measuring tools provide innovative solutions for precise measurement of lengths, distances and angles.

In addition, Nedo manufactures special measuring tools for axle alignment and measurement of vehicle body parts.

Nedo mEssfix is the classic product in its line of measuring tools. This telescopic rule with an integrated analogue display is ideal for quick and precise measurement of clear dimensions, as thousands of users have discovered. It is indispensable in window making and many other areas of interior finishing.

Nedo **mEsstronic 2** is the new generation of digital telescopic measuring stick with Bluetooth interface.

The **laser mEssfix 50** is the **mEssfix** among the laser distance measuring instruments: robust, reliable and accurate.

Nedo measuring wheels are ideal for accurate measurement of distances up to 9,999.99 m in road and path construction.

Winkelfix and **Winkeltronic** measure and transfer angles of all kinds, quickly and precisely. They are essential in carpentry, cabinet making, structural steel work and the construction of kitchens and staircases.



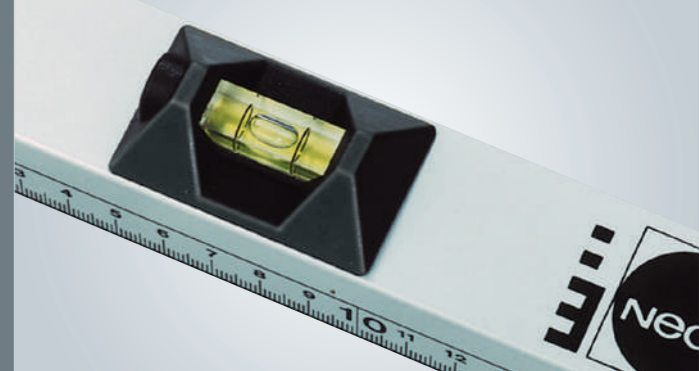

Nedo mEssfix

Nedo **mEssfix** is a thoroughly tried-and-tested telescopic measuring stick, designed to measure the widths of openings. Nedo **mEssfix** - the original. Simply place the **mEssfix** in position, pull out the extensions and read off the measurement from the analogue display. A two-way spirit level attached to the outer tube facilitates taking vertical and horizontal measurements. The built-in metal measuring tape and the heavy-duty rewind mechanism are made to withstand severe stresses and to guarantee accurate measurements at all times. Thanks to its ease of use, reliability and sturdiness, the Nedo **mEssfix** has become indispensable in most skilled trades, such as in window frame making or interior outfitting.

All **mEssfix** units conform to accuracy class II $\Delta l = 0,3 + 0,2 \cdot L(m)$.

Features:

- Rugged telescopic measuring stick
- Housing made of impact-resistant plastic
- Bubble for horizontal and vertical alignment
- Sections made of sturdy, rectangular-profile aluminium
- Supplied with case as a standard
- Made in Switzerland

Nedo **mEssfix** - the original

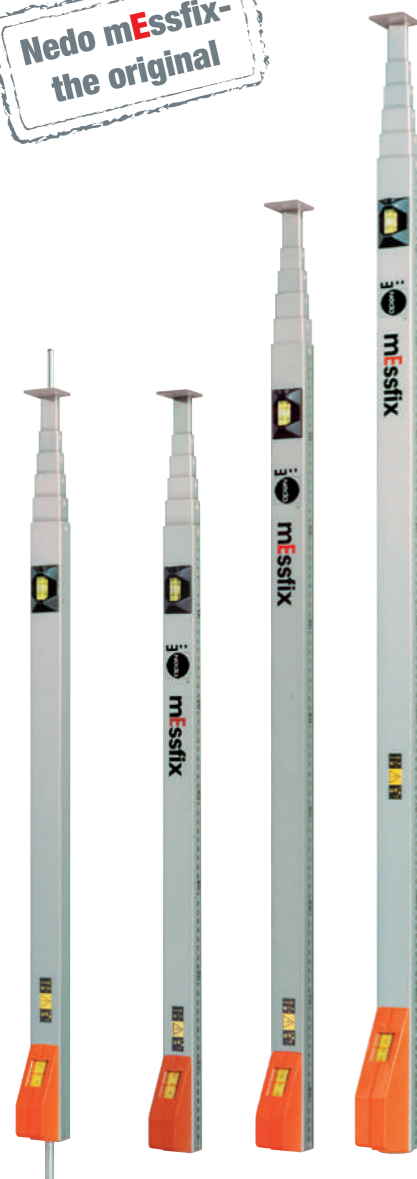

SWISS MADE

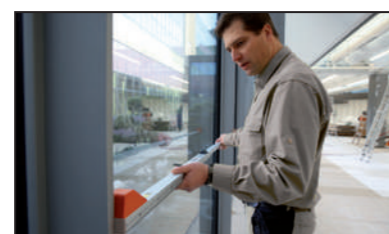

Supplied with case as a standard

Nedo mEssfix

Ref.-No.	Measuring range	Length retracted	Graduations	Weight	Incl. case
F 180 111	0.37 to 1.00 m	0.37 m	mm	0.7 kg	yes
F 280 111	0.53 to 2.00 m	0.53 m	mm	0.9 kg	yes
F 280 113	0.53 to 2.00 m	0.53 m	mm/inch	0.9 kg	yes
F 380 112	0.70 to 3.00 m	0.70 m	mm	1.1 kg	yes
F 380 113	0.70 to 3.00 m	0.70 m	mm/inch	1.1 kg	yes
F 480 111	0.86 to 4.00 m	0.86 m	mm	1.4 kg	yes
F 480 113	0.86 to 4.00 m	0.86 m	mm/inch	1.4 kg	yes
F 580 111	1.07 to 5.00 m	1.07 m	mm	1.7 kg	yes
F 580 115	1.07 to 5.00 m	1.07 m	mm/inch	1.7 kg	yes

Nedo mEssfix with Points for Roller Shutter Constructors

Ref.-No.	Measuring range	Length retracted	Graduations	Weight	Incl. case
F 381 111	0.80 to 3.10 m	0.80 m	mm	1.2 kg	no
F 481 111	0.96 to 4.10 m	0.96 m	mm	1.5 kg	no
F 581 111	1.17 to 5.10 m	1.17 m	mm	1.8 kg	yes

Cases for Nedo mEssfix with Points for Roller Shutter Constructors

Ref.-No.	Type	For model Ref.-No.
615 111	case	F 381 111

Calibration certificate for Nedo mEssfix

Ref.-No.	399 551 calibration certificate for mEssfix tools 1 m to 5 m

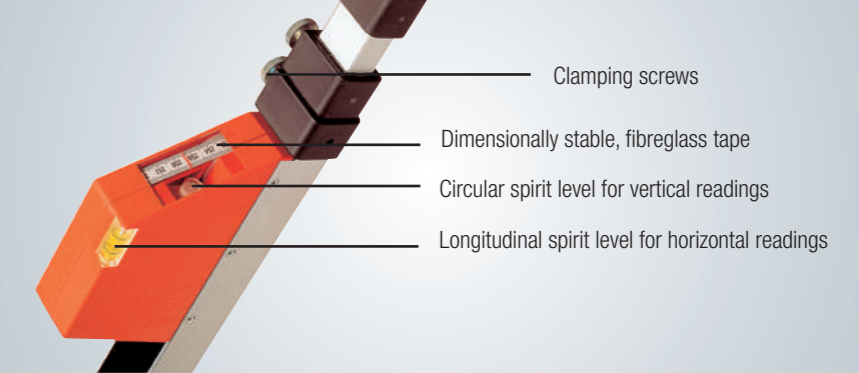
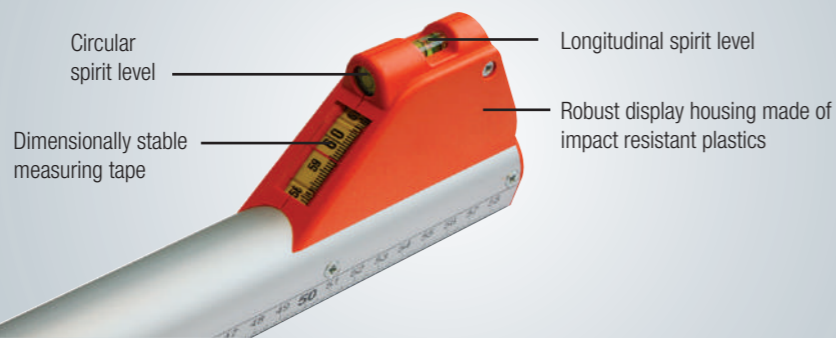

Nedo mEssfix compact

The lightweight and handy telescopic measuring stick **mEssfix compact** is an aggressively priced alternative to the **mEssfix**. It is designed to measure interior dimensions quickly, reliably and with the utmost ease. Simply place the **mEssfix compact** in position, pull out the extensions and conveniently read off the measurement from the analogue display. Ideal in interior outfitting. Nedo **mEssfix compact** is very handy thanks to its compact dimensions, its light weight and its round telescopic tubes.

The display is attached at the foot of the **mEssfix compact**, so when measuring windows, the measured values can conveniently be read off at eye level. A two-way bubble is integrated into the display housing to facilitate taking horizontal and vertical measurements.

All **mEssfix compact** units conform to accuracy class II $\Delta l = 0,3 + 0,2 \cdot L(m)$

Features:

- Compact dimensions
- Robust display housing with horizontal/vertical bubbles
- Circular telescopic tubes for convenient handling
- Supplied with case as a standard
- Made in Switzerland



Nedo mEssfix compact

Ref.-No.	Measuring range	Length retracted	Graduations	Weight	Incl. case
F 380 211	0.60 to 3.04 m	0.60 m	mm	0.9 kg	yes
F 580 211	0.91 to 5.01 m	0.91 m	mm	1.4 kg	yes

Calibration certificate for Nedo mEssfix compact

Ref.-No.	399 551 calibration certificate for mEssfix compact tools 1 m to 5 m
----------	--

Nedo mEssfix-S

With a measuring range of up to 8 m the **mEssfix-S** is the ideal helper on the construction site, e.g. for work on scaffolding, for measurements of facades or for the determination of clearances. The display is attached on the upper end of the rod which allows for a convenient read-off.

All **mEssfix-S** units conform to accuracy class III $\Delta l = 0,6 + 0,4 \cdot L(m)$

Features:

- Measuring ranges: 5 m, 6 m and 8 m
- Display unit contains two integral spirit levels, conveniently placed at eye level
- Circular spirit level for vertical alignment
- Longitudinal spirit level for horizontal alignment
- Telescopic sections made of sturdy, rectangular-profile aluminium
- Clamping screws allow extending sections to be locked in any position
- Supplied with case as a standard
- Made in Switzerland



Nedo mEssfix-S

Ref.-No.	Measuring range	Length retracted	Graduations	Weight	Incl. case
F 580 151	1.03 to 5.00 m	1.03 m	mm	2.0 kg	yes
F 680 151	1.20 to 6.00 m	1.20 m	mm	2.4 kg	yes
F 880 151	1.53 to 8.00 m	1.53 m	mm	2.6 kg	yes

Calibration certificate for Nedo mEssfix-S

Ref.-No.	399 552 calibration certificate for mEssfix-S tools 5 m to 8 m
----------	--



Nedo Auto-mEssfix

Nedo **Auto-mEssfix** is the telescopic gauge for quick checking and measurement of deformed or already restraightened vehicle body parts. Ideal for assessing the extent of damage, measuring structural damage or for checking of dimensions after restraightening. Simply pull out the extending sections and read off the distance between two measurement points from the analogue display. Quick, reliable and precise. Choose from three sturdy models. The two larger models are fitted with clamping screws for fixing the extendable tubes; this prevents inadvertent displacement of the settings.



Nedo Auto-mEssfix

Ref.-No.	Measuring range	Length retracted	Graduations	Weight	Incl. case
F 281 119	415 to 945 mm	415 mm	mm	1.3 kg	no
F 281 219	920 to 2610 mm	920 mm	mm	1.8 kg	no
F 281 319	950 to 3260 mm	950 mm	mm	2.0 kg	no

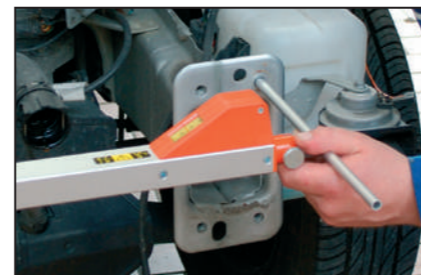

Measurements in almost inaccessible places can be made with the aid of spikes which are supplied as a standard. Distances between two points lying in different planes are determined rapidly and easily. The delivery also includes measuring cones that allow for measurements of intervals between holes.

Delivery includes two of each of the illustrated measuring accessories.



Arm for truck measurement

Nedo Truck & Trailer mEssfix

The telescopic rule to conveniently measure the height of trucks, trailers and construction vehicles. The measured values can be easily read off from the analogue display. With removable cross-arm for easy handling and convenient transport. Includes case.

The Nedo **Truck & Trailer mEssfix** conforms to accuracy class III $\Delta l = 0,6 + 0,4 \cdot L(m)$

Features:

- Measuring range: 1.45 m to 5.16 m
- Graduations: mm/cm
- Arm for truck measurement (1.25 m long)
- Supplied with case as a standard
- Made in Switzerland



Nedo Truck & Trailer mEssfix

Ref.-No.	Measuring range	Length retracted	Graduations	Weight	Incl. case
687 811	1.45 to 5.16 m	1.45 m	mm	3.0 kg	yes

Optional you can receive the Nedo **Truck & Trailer mEssfix** with assessment of conformity.
Ref.-No. 687 811-600

Nedo Telemeter

The Nedo **Telemeter** is a practical all-purpose measuring rod for interior and exterior use. It can be used in building work, interior outfitting and the construction of exhibition stands and work on scaffolding.

The 1 m extending sections run between abrasion-resistant plastic guides which also serve as wiper blades. By means of practical pushbuttons, the Nedo **Telemeter** can be reliably locked, thus preventing the telescopic elements from being retracted unintentionally.

The Nedo **Telemeter** conforms to accuracy class III $\Delta l = 0,6 + 0,4 \cdot L(m)$

Nedo Telemeter

Ref.-No.	Measuring range	Length retracted	Graduations	Weight	Incl. case
F 575 313	1.12 to 5.00 m	1.12 m	mm	1.15 kg	no

Case for Nedo Telemeter

Ref.-No.	Type	For model Ref.-No.
372 111-613	case	F 575 313





Nedo mEsstronic 2 with Bluetooth®

Nedo **mEsstronic 2** is the new generation of digital telescopic rules for measuring clear dimensions in interior finishing. The new **mEsstronic 2** features an integrated Bluetooth interface, a large illuminated display and a very robust design. The integrated Bluetooth interface can transmit measurement values directly to a smartphone, tablet or laptop. The large illuminated display of the **mEsstronic 2** is easy to read, even in unfavourable light conditions. The hold function lets you capture the measured value on the display. The value flashes to show activation of the hold function. A two-way bubble level integrated in the display housing facilitates measurements in both the horizontal and vertical position. The automatic shut-off prevents unnecessary discharging of the two AA batteries. With its measurement ranges of up to 3 m and up to 5 m, the new **mEsstronic 2** with Bluetooth is suited for all typical measurement tasks in interior finishing.

Features:

- Bluetooth interface for transmitting measurement values (Bluetooth 5.2 LE)
- Simple coupling with a mobile device
- Compatible with iOS, Android and Windows
- Illuminated display
- Hold function for capturing values
- Power supply 2 x 1.5 V AA batteries
- Automatic shut-off after 3 minutes of non-use
- Operating time approx. 100 h
- Integrated bubble levels for horizontal and vertical use
- Padded carrying bag supplied as standard



Digitalization in measurement: mEsstronic 2 with Bluetooth®

The new **mEsstronic 2** with Bluetooth enables measurements to be taken quickly and easily and then transmitted to a mobile device like a smartphone, tablet or laptop. Since no special software is required to do so, the measured values can be used directly in any document or app on a mobile device. **mEsstronic 2** is compatible with iOS, Android and Windows.

Just take the measurement, mark the required box in your app and then press the Bluetooth key of the **mEsstronic 2**: the measured value is now available on the mobile device for further processing. No more tiresome manual entry of the measured values into a measurement sheet. That saves time and prevents errors.

The new **mEsstronic 2** with Bluetooth for digitalization in measurement.



Nedo mEsstronic 2 with Bluetooth

Ref.-No.	Measuring range	Accuracy	Length retracted	Graduations	Resolution	Weight	Incl. case	Incl. bubble
583 131	0.70 m to 3.00 m	± 1 mm	0.70 m	mm/inch	1 mm	1.4 kg	yes	yes
585 131	1.05 m to 5.00 m	± 1 mm	1.05 m	mm/inch	1 mm	2.1 kg	yes	yes



Nedo Bluetooth Module BlueConnect 2

The Bluetooth module *BlueConnect 2* permits simple wireless transmission of inside dimensions measured with the Nedo mEsstronic 0.1 to a PC or to a machine control unit.

Ref.-No. 585 230



Nedo Memory Module

The memory module stores 511 values measured with the mEsstronic or 250 values measured with the mEsstronic 0.1.

Ref.-No. 585 115



Distances up to 50 m, as quick as a flash and exact down to the last millimetre.



Nedo mEsstronic 0.1

Nedo **mEsstronic 0.1** is an electronic length measuring tool for high precision measurements. Thanks to its high accuracy and the resolution of 0.1 mm this measuring tool is primarily used to measure of glazing bars.

The measured values are shown on the large, easy-to-read digital display. Two measuring ranges are at the user's disposal: 0.15 m to 2.35 m and 0.803 m to 3.00 m. It is possible to switch from one range to another at any time with the touch of a button.

Reference points for relative measurements can be set by using the zero function. **mEsstronic 0.1** features a data interface to save measured values on a memory module or to transfer with Bluetooth module to the control unit of a glazing bead saw.

Features:

- Two measuring ranges: 0.15–2.35 m and 0.803–3.00 m (change of range via pushbutton)
- Resolution: 0.1 mm
- Accuracy: ± 0.3 mm
- Power supply: 4 x 1.5 V batteries type (AA) or 4 x 1.2 V rechargeable batteries
- Operation duration: approx. 150 hours
- Automatic switch-off after 3 minutes of non-use
- Zero function: sets reference points for relative measurements
- Recess for memory module or Bluetooth module

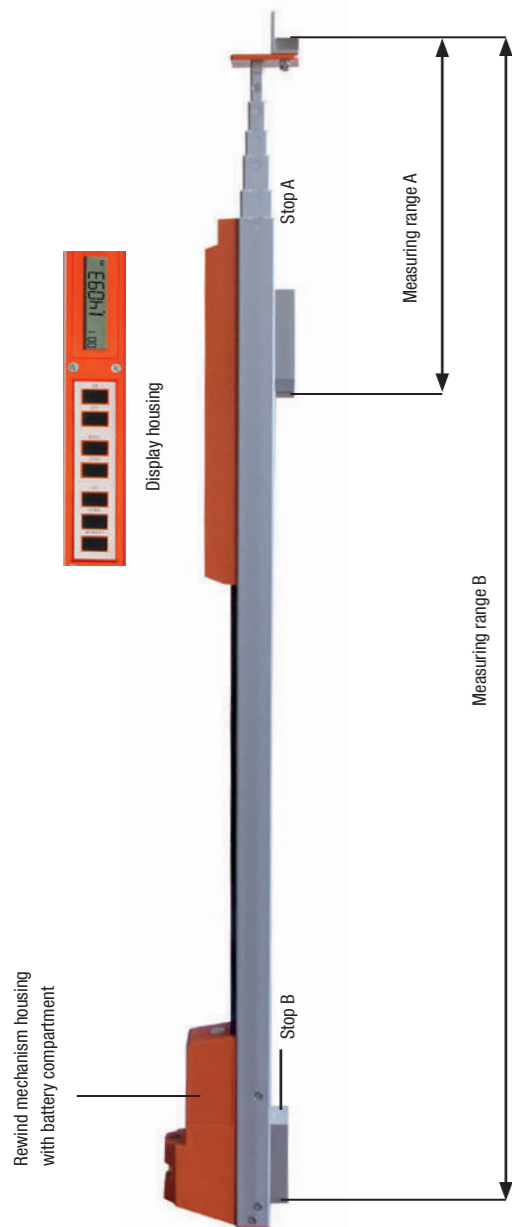

Nedo mEsstronic 0.1

Ref.-No.	Measuring range	Accuracy	Length retracted	Resolution	Weight	Incl. case	Incl. bubble
583 115	0.15 m to 2.35 m or 0.803 m to 3.00 m	± 0.3 mm	0.803 m	0.1 mm	1.9 kg	no	yes



Nedo laser mEssfix 50

Nedo **laser mEssfix 50** is a small, handy and extremely robust laser distance meter of real professionals. It has a measuring range 0.05 m to 50 m and an accuracy of ± 2.0 mm.

Measurements can be taken from the device's front edge or back edge. Numerous measuring functions help to save time during surveying operations. The last ten measurements can be stored and recalled.

Features:

- Measurements can be made from the device's front edge or back edge
- Clear, 2-line display
- Area and volume calculation
- Pythagoras function
- Single or continuous measuring
- Addition / Subtraction
- Small, handy and robust
- IP 54 splashwater protection
- Information on range and accuracy comply with ISO 16331-1

Nedo laser mEssfix 50

Ref.-No.	705 584
Typ. measuring accuracy	± 2.0 mm
Measuring range	0.05 m to 50 m
Laser	laser class 2, 635 nm
Automatic switch-off	after approx. 3 minutes
Power supply	2 x 1.5 V type AAA batteries
Measurements per battery set	approx. 5000
Dimensions	approx. 116 mm x 45 mm x 29 mm
Weight	100 g

Also available in a pack of 5 pieces with a practical display!

Ref.-No. 705 585

Optional accessory:
Leica DST360 adapter for Point to Point measurements (P2P)
 The **Leica DST360** adapter lets you measure horizontal and vertical angles and transmit them automatically to the **DISTO™ X3** or **X4**. In this way you can use the **DISTO™ X3** or **X4** for quick, accurate measurement of distances between any two points in space, even when they are inaccessible. A fine adjustment facilitates targeting.
 The **Leica DST 360 adapter** is extremely robust and has an IP 67 rating. It comes with a tripod and carrying case.

Ref.-No. 705 588



Bluetooth® Smart technology allows data transfer to smartphones and tablets. In addition to the smart free App **Leica DISTO™ Plan**, there is also a host of other Apps to allow you to work efficiently and avoid typing errors when recording measurement results.



Leica DISTO™ X3 and X4

The **DISTO™** models **X3** and **X4** combine innovative measurement technology with an extremely robust design for use on construction sites. **DISTO™ X4** is equipped with a digital pointfinder, making it perfect for outdoor applications.

When used with the **Leica DST360** adapter the **DISTO™ X3** and **X4** can make point-to-point measurements and record 3D measurement data.

Features:

- Passes drop tests from up to 2 m height
- Protected against water jets and dust as per IP 65
- Integrated 360° tilt sensor
- Integrated acceleration and position sensors for innovative measurement functions
- Rotatable display
- Simple, intuitive operation
- Bluetooth® smart interface
- **DISTO™ X4** with digital pointfinder (camera) and 4x zoom
- Information on range and accuracy in accordance with ISO 16331-1



Leica DISTO™ X3 and X4

Ref.-No.	705 586 (DISTO™ X3)
Ref.-No.	705 587 (DISTO™ X4)
Typ. measuring accuracy	± 1.0 mm
Measuring range	0.05 m - 150 m
Accuracy tilt sensor	± 0.2°
Power supply	2 x 1.5 V type AA batteries
Measurements per battery set	approx. 4000
Dimensions	approx. 132 mm x 65 mm x 29 mm
Weight	184 g



Leica DISTO™ X4 P2P Set
 Incl. Leica DISTO™ X4, case, batteries, adapter **Leica DST360**, Tripod and case

Ref.-No. 705 589



www.nedo.com

Leica DISTO™ Plan

The new **Leica DISTO™ Plan** app allows you to transmit measurement data via Bluetooth® to a smartphone or tablet for documentation and visualisation. The app lets you create sketches and integrate dimensions. The sketch gets truer to scale with the addition of each measurement value and becomes a scalable CAD drawing.

In simple cases the individual measurements are automatically combined to form a ground plan. It is also possible to edit photos with measurements. **Leica DISTO™ Plan** is available for IOS and Android devices.



Leica DISTO™ D2

Leica DISTO™ D2 features a measuring range of up to 100 m and many interesting functions. The precise measurements can be transferred to the **Leica DISTO™ Plan** app on a smartphone or tablet.

Ref.-No. 705 576



Leica DISTO™ D5

Leica DISTO™ D5 is particularly suitable for distance measurements in outdoor areas. Thanks to the digital viewfinder, high functionality and the compatibility with **Leica DISTO™ Plan** app, every measuring situation is solved quickly and efficiently.

Ref.-No. 705 610



Leica DISTO™ X6

Leica DISTO™ X6 for rough construction site use. The perfect combination of digital viewfinder, ergonomic operation with touchscreen and additional measuring button on the side, as well as high functionality, guarantees that every measuring task can be completed quickly and efficiently.

Ref.-No. 705 612



Features:

- Accuracy: ± 1.5 mm
- Measuring range: 0.05 m – 100 m
- Units: m, ft, in
- Bluetooth® smart interface
- Illuminated display
- Protection class IP 54
- Recall last 10 values
- Multifunctional end-piece
- Area and volume calculation
- Addition / subtraction



Features:

- Accuracy: ± 1.0 mm
- Measuring range: 0.05 m - 200 m
- Digital viewfinder with 4 x zoom and high resolution colour display
- Dust-proof and splashwater protected in accordance with IP 65
- Trigger measurement by hand signal
- Various measurement functions, such as Smart Horizontal Mode for measuring over obstacles, height tracking, profile and angle measurements
- Bluetooth® 5 interface



Leica DISTO™ D5 Set
 Ref.-No. 705 611



Features:

- Accuracy: ± 1.0 mm
- Measuring range: 0.05 m - 250 m
- Digital viewfinder with 4 x zoom and high resolution colour display
- Dust-proof and splashwater protected in accordance with IP 65
- Trigger measurement by hand signal
- Various measurement functions, such as Smart Horizontal Mode for measuring over obstacles, height tracking, profile and angle measurement
- Bluetooth® 5 interface
- Touchscreen

Leica DISTO™ X6 Set
 Ref.-No. 705 613

Nedo Super Measuring Wheel, with railroad track guide. Perfect when measuring distances on railway tracks.



Transport case for Nedo Super measuring wheel.
Ref.-No. 752 111



Nedo Super Measuring Wheel

For accurate measurement of long distances.

Nedo measuring wheels are ideal for accurate measurement of distances in road construction, walkway construction and track laying.

The Nedo **Super measuring wheel** meets the highest standards in terms of precision, quality and reliability.

Thanks to tight manufacturing tolerances and a high-quality counter, its accuracy is $\pm 0.02\%$, which corresponds to a maximum error of ± 2 cm over a distance of 100 m. The counter, which has a display resolution in cm, is mounted securely above the wheel and is driven by a toothed belt. Zero setting is done with a hand lever.

The brake is integrated into the sturdy rest support. The ergonomic pistol grip and the rugged aluminium guide bar make handling easy at all times. A clever mechanism permits the guide bar to be folded away for transport.

Nedo Super Measuring Wheel

Ref.-No.	702 111
Wheel circumference	1 m
Measuring range	0 to 9.999,99 m
Counter arrangement	central
Resolution	0.01 m
Weight	approx. 3.65 kg
Tolerance	$\pm 0.02\%$

Nedo Railroad Track Guide

The **track guide** keeps the Nedo Super measuring wheel from slipping off the track, making it suitable for measurements on railway tracks.

It can be fitted easily without tools.

Ref.-No. 702 210





The Nedo lightweight measuring wheel is protected against low pressure jet water and dust in line with IP 65. After use, the lightweight measuring wheel can even be sprayed down with water to clean it.



Nedo Lightweight Measuring Wheels

Nedo **lightweight measuring wheels** stand out thanks to its sturdy, ergonomic design. The abrasion-proof precision wheel and the precision counter ensure exact measurements. The pistol grip with an integrated brake button makes handling easy. A clever hinge mechanism permits the guide bar to be folded away, reducing the package dimensions to a minimum.

Features:

- Robust and reliable
- Ergonomic design
- Precision wheel
- Precision counter with 0.01 m resolution
- Packed into a very small space

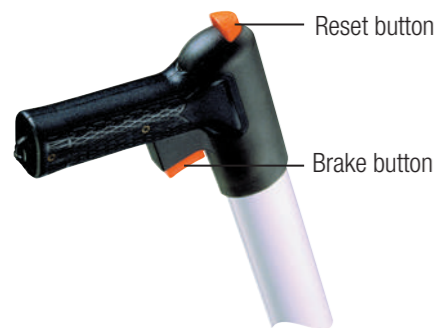

Reset button

Brake button

Nedo Lightweight Measuring Wheel Professional

Ergonomically shaped pistol grip with brake and reset button.

Nedo Lightweight Measuring Wheel Digital

The **lightweight measuring wheel** Digital is equipped with an easy-to-read digital display with resolution in centimetres. Various display formats m/cm, m/dm and m are optionally available. The device also features a hold function to retain the measured values and an automatic switch off function.

Features:

- Power supply: 2 x 1.5 V AA
- Operation duration: more than 350 h
- Protection class: IP 65
- Automatic switch-off after 3 minutes of non-use



Mini Measuring Wheel

Small and compact

Lightweight Measuring Wheel Econo

Attractive price

Lightweight Measuring Wheel Deluxe

Robust and reliable

Lightweight Measuring Wheel Professional

Easy handling

Lightweight Measuring Wheel Digital

Digital display with cm resolution

	Mini Measuring	Lightweight Measuring Wheel Econo	Lightweight Measuring Wheel Deluxe	Lightweight Measuring Wheel Professional	Lightweight Measuring Wheel Digital
Ref.-No.	703 113	703 116	703 111	703 112	703 118
Ref.-No. Set (with trekking rucksack)	703 125	703 126	703 115	703 120	703 128
Wheel circumference	0,5 m	1 m	1 m	1 m	1 m
Measuring range	0-9,999.90 m	0-9,999.90 m	0-9,999.90 m	0-9,999.90 m	0-9,999.90 m
Resolution	0.01 m	0.01 m	0.01 m	0.01 m	0.01 m
Weight	1.2 kg	2.1 kg	2.3 kg	2.4 kg	1.85 kg
Tolerance	± 0.05%	± 0.05%	± 0.05%	± 0.05%	± 0.05%

Calibration certificate for Nedo Lightweight Measuring Wheels

Ref.-No.	399 550 calibration certificate for lightweight measuring wheels
-----------------	---



Tous les odomètres sont également disponibles sous forme de set avec un sac à dos de randonnée.



Degrees can be read off immediately from the analogue display. Display graduations: $\pm 0.5^\circ$ Measuring accuracy: $\pm 0.25^\circ$



Degrees can be read off immediately from the illuminated digital display. Display graduations: $\pm 0.05^\circ$ Measuring accuracy: $\pm 0.1^\circ$



Nedo Winkelfix

With Nedo **Winkelfix**, measurements of angles are performed quickly, precisely and with the utmost ease.

Simply place the Nedo **Winkelfix** in position and the angle can be rapidly read off from the analogue display. Two integral spirit levels ensure true horizontal and vertical positioning. Thanks to its reliability, sturdiness and convenience, the Nedo **Winkelfix** has proven its value to the building trade over and over again.

You too will find measuring angles easier with one of our five **Winkelfix** models!



Winkelfix long



Winkelfix classic and mini



Winkelfix maxi and shorty



Supplied with case as a standard

Nedo Winkelfix

Ref.-No.	Shank length	Graduation	Measuring range	Weight	Compass points	Incl. case
450 111 mini	430 mm	degrees	0° to 180°	0.9 kg	no	yes
450 121 classic	600 mm	degrees	0° to 180°	1.4 kg	no	yes
500 101 shorty	305 mm	degrees	0° to 180°	0.7 kg	no	yes
500 111 maxi	600 mm	degrees	0° to 180°	1.4 kg	yes	yes
510 111 long	1500 mm	degrees	0° to 180°	2.6 kg	yes	yes

Calibration certificate for Nedo Winkelfix

Ref.-No.	399 553 calibration certificate for Winkelfix tools
----------	---

Nedo Winkeltronic

The premium digital angle measuring tool for exact measuring and transferring of angles. Accuracy of $\pm 0.1^\circ$. Extremely robust and reliable. New with illuminated display, 0.05° resolution and case.



• Illuminated display
• 0,05° Resolution
• Case



Features:

- Accuracy: $\pm 0,1^\circ$
- Illuminated display
- Automatic switch-off after 3 minutes of non-use
- Hold functions keep a value on the display
- Zero adjustment at any shank angle
- Integrated horizontal and vertical spirit levels
- Supplied with case as a standard
- Power supply: 4 x 1.5 V (AA) batteries or 4 x 1.2 V rechargeable batteries



Supplied with case as a standard

Nedo Winkeltronic

Ref.-No.	Shank length	Resolution	Measuring range	Weight	Incl. case
405 216	450 mm	0.05°	0° to 352°	1.2 kg	yes
405 316	600 mm	0.05°	0° to 355°	1.5 kg	yes
405 317	750 mm	0.05°	0° to 355°	1.8 kg	yes

Calibration certificate for Nedo Winkeltronic

Ref.-No.	399 554 calibration certificate for Winkeltronic tools
----------	--



Nedo Winkeltronic Easy

Digital angle measuring tool for measuring and transferring angles. Thanks to its light weight and large display, the **Winkeltronic Easy** is ideal for use on construction sites, especially for interior outfitting.

Features:

- Accuracy: $\pm 0.2^\circ$
- Automatic switch-off
- Hold function keeps a value on the display
- Zero adjustment at any shank angle
- Integrated horizontal and vertical spirit levels
- Supplied with case as a standard
- Power supply: 2 x 1.5 V (AA) batteries or 2 x 1.2 V rechargeable batteries
- Measurements of absolute, relative and opposite angles



Supplied with case as a standard

Nedo Winkeltronic Easy

Ref.-No.	Shank length	Resolution	Measuring range	Weight	Incl. case
405 100	400 mm	0.1°	0° to 200°	0.65 kg	yes
405 120	600 mm	0.1°	0° to 200°	0.88 kg	yes

Calibration certificate for Nedo Winkeltronic

Ref.-No.	399 554 calibration certificate for Winkeltronic tools

Nedo LaserWinkeltronic

Nedo **LaserWinkeltronic** combines the advantages of the latest laser technology with the proven technology of the Nedo Winkeltronic. Many applications, such as measuring and adjusting angles when installing staircases, interior outfitting, modernisation projects and measuring roof angles are considerably simplified by the use of laser technology. Time-consuming conversions are eliminated and deviations from straight lines can be seen immediately. The laser beam travels in straight lines from the shanks of the instrument extending them up to 20 m. The Nedo **LaserWinkeltronic** is available with one or two laser beams.

Illuminated display
0.05° Resolution



Features Winkeltronic:

- Accuracy: $\pm 0.1^\circ$
- Resolution: 0.05°
- Illuminated display
- Automatic switch-off after 3 minutes of non-use
- Hold function keeps a value on the display
- Zero adjustment at any shank angle
- Integrated horizontal and vertical spirit levels
- Power supply: 4 x 1.5 V batteries (AA)

Features Laser:

- Laser class 2
- Visible red laser beam, wavelength 635 nm
- Beam diameter: 6 mm
- Range: approx. 20 m, depending on surrounding conditions
- Accuracy: ± 0.5 mm/m
- Power supply: 3 x 1.5 V batteries (AAA)

Nedo LaserWinkeltronic

Ref.-No.	Laser modules	Shank length	Resolution	Measuring range	Weight	Incl. case
460 613	1	605 mm	0.05°	0° to 360°	1.2 kg	yes
460 612	2	605 mm	0.05°	0° to 360°	1.5 kg	yes

Case for Nedo LaserWinkeltronic

Ref.-No.	Type	For model Ref.-No.
600 111-613	Case	460 612 and 460 613

Calibration certificate for Nedo LaserWinkeltronic

Ref.-No.	399 554 calibration certificate for LaserWinkeltronic tools



120 Years of Experience in the Manufacture of Surveying Accessories

The Nedo brand is inseparably linked with the surveying industry. For more than 120 years we have worked on ways to improve the efficiency of geodetic measurements by developing innovative surveying accessories. Thanks to the precision and reliability of our products, the Nedo brand has become synonymous throughout the world for surveying accessories of superlative quality.

Nedo surveying accessories have an international reputation. Our Invar levelling staffs are used in almost every major construction project where maximum precision is required: in the 57-km Gotthard Base Tunnel, in new high-speed rail lines and in the tunnels of the CERN linear accelerator.

Thanks to our many years of experience we are thoroughly familiar with operating conditions and requirements for surveying accessories. We know what is important to users and what factors are critical in their day-to-day work. This knowledge is systematically applied when we develop and manufacture our products.



Nedo QualiLine telescopic levelling staffs with adjustable circular bubble



Nedo StandardLine telescopic levelling staffs with clip bubble



Aluminium Telescopic Levelling Staffs with E-graduation

Aluminium Telescopic Levelling Staffs

To meet differing quality demands Nedo offers two series of telescopic levelling staffs.



QualiLine Telescopic Levelling Staffs

For maximum quality and accuracy, Nedo **QualiLine telescopic levelling staffs** are made of high-quality white powder-coated aluminium tubes. The rugged locking mechanism ensures that the telescopic sections lock securely into position. The levelling graduation on the front side is protected by standoff ribs. Nedo **QualiLine telescopic levelling staffs** are available with adjustable circular bubbles and graduation 1 and graduation 2 on the rear.

Nedo **QualiLine telescopic levelling staffs** comply to the standard DIN 18703.

StandardLine Telescopic Levelling Staffs

Reliable quality at an attractive price. Nedo **StandardLine telescopic levelling staffs** are made of anodised aluminium section tubes to withstand extreme demands on the construction site. A reliable locking mechanism ensures that the telescopic sections lock securely into position. **StandardLine telescopic levelling staffs** are available with graduation 1 and 2 on the rear. The staffs are supplied with a carrying bag and clip-on bubble.

Graduations on the Rear

Graduation 1

Graduation for measurements of internal room heights.

Graduation 2

Continuous mm-graduation, beginning with 0 at the staff's shoe.

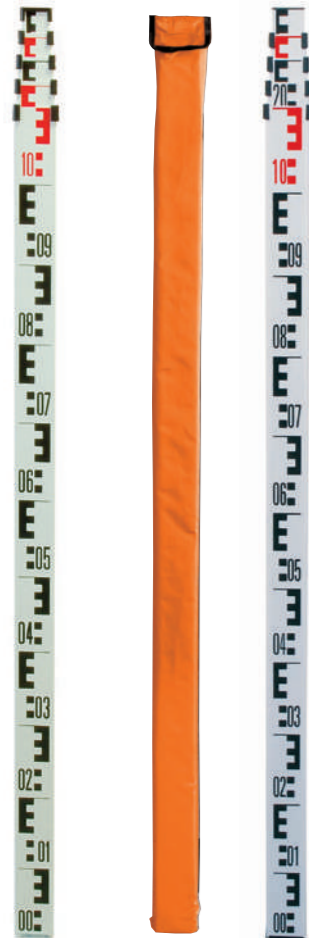

QualiLine Telescopic Levelling Staffs

StandardLine Telescopic Levelling Staffs



Graduation 1



Graduation 2

Nedo QualiLine Telescopic Levelling Staffs

Ref.-No.	Graduation on rear	Circular bubble	No. of sections	Length retracted	Measuring range	Weight
343 122-101	2	-	3	1.16 m	3.00 m	1.40 kg
344 121	1	adjustable	4	1.19 m	4.00 m	1.80 kg
344 122	2	adjustable	4	1.19 m	4.00 m	1.80 kg
345 121	1	adjustable	5	1.22 m	5.00 m	2.10 kg
345 122	2	adjustable	5	1.22 m	5.00 m	2.10 kg

Nedo StandardLine Telescopic Levelling Staffs

Ref.-No.	Graduation on rear	Clip-on bubble	No. of sections	Length retracted	Measuring range	Weight
344 115-637	1	yes	4	1.22 m	4.00 m	1.50 kg
344 122-637	2	yes	4	1.22 m	4.00 m	1.50 kg
345 115-637	1	yes	5	1.22 m	5.00 m	1.80 kg
345 122-637	2	yes	5	1.22 m	5.00 m	1.80 kg
347 122-637	2	yes	5	1.69 m	7.00 m	2.30 kg

Optional Accessories

Ref.-No.	
355 111-613	Bag, suitable for telescopic levelling staffs 3 m, 4 m and 5 m
350 215	Snap-on bubble for QualiLine telescopic levelling staffs
062 525	Clip-on bubble for StandardLine telescopic levelling staffs



Adjustable circular bubble



Special Levelling Staffs

Fibreglass Levelling Staffs

Nedo **fibreglass levelling staffs** are especially sturdy and durable. The fibreglass sections are almost indestructible. The graduation on the front is protected by stand-off ribs.

Nedo **fibreglass levelling staffs** are non-conducting when dry and are therefore especially suitable for levelling close to power lines or railways. Supplied with a bag as a standard.

Nedo Fibreglass Levelling Staffs

Ref.-No.	Length retracted	Measuring range	Locking buttons	Snap-on bubble	Graduation on the rear	Weight
345 815	1.23 m	5.00 m	brass	yes	Graduation 1	2.7 kg
345 822	1.25 m	5.00 m	brass	yes	Graduation 2	2.7 kg
870 100	1.68 m	7.60 m	plastic	no	Graduation 1	3.2 kg

Nivellierfix

Thanks to the small diameter of its telescopic tubes, **Nivellierfix** is lightweight and compact. It is ideal for levelling and measuring interior dimensions.

The E-block scale on the front and the mm graduation on the back are equipped with an abrasion-proof anodised surface. The sturdy, locking mechanism never fails.

Available in lengths of 3 m, 4 m and 5 m.

A carrying bag is available as an accessory.

Nedo Nivellierfix

Ref.-No.	Measuring range	Sections	Graduation	Weight
F 373 313	3.00 m	3	mm/E	0.8 kg
F 374 312	4.00 m	4	mm/E	1.0 kg
F 375 312	5.00 m	5	mm/E	1.1 kg

Accessory: case
Ref.-No.
372 111-613

www.nedo.com

Folding Levelling Staffs

Levelling Staffs, Wood

Features:

- Cross-section: 53 mm x 20 mm
- Wooden core of straight-fibered premium quality knot-free spruce or pine wood
- PVC coating encloses the wooden core like a box
- Double-coated narrow sides
- Galvanically zinc plated hinges and brackets
- DIN 18703

Levelling Staffs, Aluminium

Features:

- Cross-section: 53 mm x 20 mm
- Very strong profile tubes with high stand-off ribs
- Profile tubes white powder-coated
- DIN 18703

Nedo Wooden Levelling Staff, 53 mm

Ref.-No.	Length folded	Measuring range	Weight	Circular bubble
326 112-615	1.00 m	4.00 m	3.8 kg	adjustable

Nedo Aluminium Levelling Staff, 53 mm

Ref.-No.	Length folded	Measuring range	Weight	Circular bubble
326 312-615	1.00 m	4.00 m	3.8 kg	adjustable

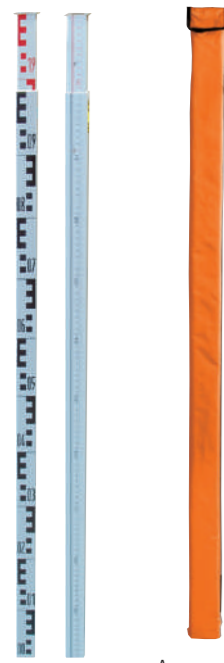
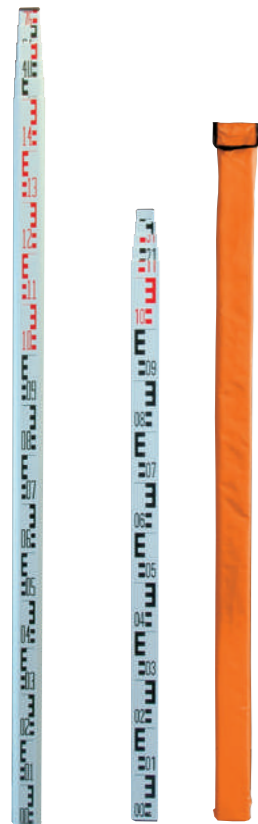

The European research centre CERN operates the world's largest particle accelerator. Here elementary particles are accelerated to nearly the speed of light and then made to collide. Scientists use these experiments to explore conditions at the time of the Big Bang, when matter came into being.

The experiments are performed in a 27 km ring of superconducting magnets. These magnets as well as countless of sensors must be kept in perfect alignment. Exact horizontal positioning of these components over a distance of 27 km was a huge technical challenge. It was solved with Nedo precision Invar levelling staffs. The photo shows the inside of the tunnel. A Nedo precision Invar levelling staff has been placed at a reference point on the pipe.



Nedo precision Invar levelling staffs are used for first-order levelling, for example in the construction and monitoring of dams.



Nedo Precision Invar Levelling Staffs

Nedo **precision Invar levelling staffs** are used for first-order levelling and for challenging work on large scale construction sites, for example tunnels, roads, dams or power plants. The graduation of the **precision Invar levelling staffs** is engraved in the paint coating with an interferometrically controlled laser beam, ensuring superior graduation accuracy and edge sharpness. The permissible deviation is $|\Delta L| \leq 0.01 + l \cdot 10^{-5}$. Nedo Invar levelling staffs thus conform to the highest accuracy class A as per DIN ISO 12858-1.

Features:

- Body of Invar staff made of rigid aluminium profile with anodised surface
- Yellow lacquered graduation side; print protected by a 0.1 mm polyester coating
- Invar tape seated in protected groove of staff profile and tensioned by soft spring to compensate the extension coefficient of the staff profile. Coefficient of thermal expansion < 1,5 ppm/k
- Foot plate slightly protrudes from staff body
- Foot plate of chrome-alloy, chemically nickel-plated steel; hardened and ground
- Equipped with circular bubble and fold-away handles as a standard. The handles are zinc and powder-coated.

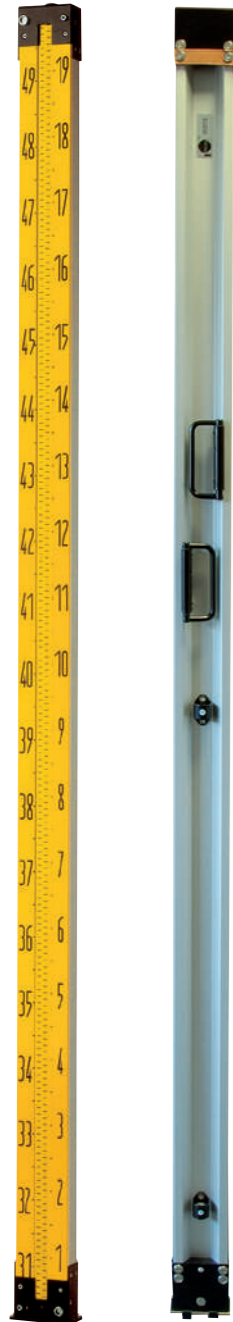

Staff profile

Available Invar staff graduations

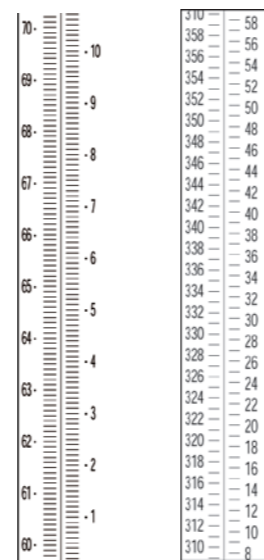

15a
0.5 cm

19a
1.0 cm



Universal Adapter for Standard Staff Shoes

The universal adapter can be used to compensate for small wall projections or similar shapes.

Ref.-No. 393 006

Nedo Invar Levelling Staffs

Staff Shoes	Ref.-No. Graduation 15a	Ref.-No. Graduation 19a	Length	Weight
Standard staff shoes		391 189	1 m	3.0 kg
Standard staff shoes	392 185	392 189	2 m	4.3 kg
Standard staff shoes		393 189	3 m	5.5 kg

Calibration Certificate

As an option, each Invar staff can be supplied with a calibration certificate. Certificates are issued by the Technical University of Munich or by Nedo, depending on the customer's requirements.

- Ref.-No. 399 511** Length calibration without temperature cycle, adjuster Nedo Dornstetten
- Ref.-No. 399 519** Length calibration without temperature cycle, adjuster Technical University of Munich
- Ref.-No. 399 521** Length calibration with temperature cycle, adjuster Technical University of Munich

The positions of the magnets and sensors in the CERN accelerator had to be measured with maximum precision under unfavourable lighting conditions. The LEDs on the staff gave uniform illumination to the barcode without emitting thermal radiation. LED staff illumination is ideally suited for use with precision Invar levelling staffs. It permits precise measurements even with poor lighting.



Precision Invar Levelling Staff Accessories

Nedo LED Invar Staff Illumination

LED Invar staff illumination for Nedo high precision Invar staffs. The **LED Invar staff illumination** allows measurements to be taken with the Invar staff and a digital level in absolute darkness.

It can be used for example in mines, tunnels, night-time construction sites and for building monitoring. The measurement results are just as precise as measurements in daylight. Thanks to its compact design and integrated power supply, the mobility of the Invar staff is not reduced. Highly efficient LEDs in combination with specially designed optics and an optimized electronic unit ensure a long operating life. The lighting does not weaken during the battery running time, so dependable measurement is always possible. The system can be fitted to an Invar staff by the customer himself using standard tools, and requires no maintenance. The circular level of the Invar staff is additionally lit to permit precise measurements.

Features:

- Protection class IP 54
- Operating temperature -10°C to +50°C
- Level lighting
- Battery status display
- Detachable rechargeable battery with low self-discharge
- Battery life 5 to 10 hours depending on length
- Supplied with rechargeable batterie and charger

Nedo LED Invar Staff Illumination

Ref.-No.	Length
396 115	suitable for 3 m Leica bar code Invar staff
396 116	suitable for 2 m Leica bar code Invar staff
396 117	suitable for 3 m Trimble bar code Invar staff
396 118	suitable for 2 m Trimble bar code Invar staff

Base Plate (Frog)

The base plate is made of powdercoated grey cast iron.

Features:

- Spike
- Weight: 2.7 kg

Ref.-No. 333 121

www.nedo.com

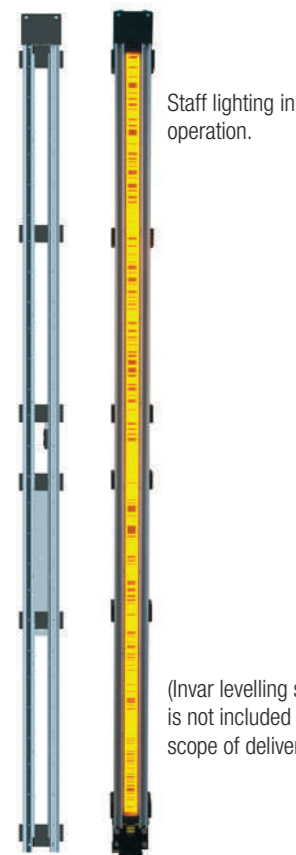

Staff lighting in operation.

(Invar levelling staff is not included in scope of delivery)



Precision Invar Levelling Staff Accessories

Nedo Telescopic Struts

Telescopic struts are available as accessories for 2 m and 3 m precision Invar levelling staffs. The easy to handle **telescopic struts** ensure a secure stand of the precision Invar levelling staffs.

Nedo Telescopic Struts

Ref.-No.	Length
399 211	2 m
399 311	3 m



Nedo Transport Case for 2 Invar Staffs

Case for safe transport and storage of Nedo precision Invar levelling staffs. The **transport case** is made up of a sturdy aluminium frame and strong plastic honeycomb structured wall panels. The corners feature robust protectors. Handles allow for an easy handling. In addition, the case has a foam lining to protect the precision Invar levelling staffs. The **transport case** can accommodate two precision Invar levelling staffs, one precision Invar levelling staff with telescopic struts or one precision Invar levelling staff with illumination.

Nedo Transport Case for 2 Invar Staffs

Ref.-No.	Length
395 111	for 1 m staff length
395 121	for 2 m staff length
395 131	for 3 m staff length

Nedo Case for 2 Invar Staffs with Wide Staff Shoes

Ref.-No.	Length
395 221	for 2m staff length
395 231	for 3m staff length



Optional Accessories LumiScale

- Power adapter plug Ref.-No. 030 816
- Charger Ref.-No. 030 827
- Rechargeable batteries Ref.-No. 061 866-900



Charger

Rechargeable batteries

Power adapter plug

Circular Bubbles, Staff Levels and Folding Levelling Rules



Staff Level Ref.-No. 194 100

- Adjustable
- Sensitivity: 12'



Staff Level Ref.-No. 194 110

- Adjustable
- Sensitivity: 25'



Circular Bubble Ref.-No. 351 211

- Removable
- Dovetail guide
- Sensitivity: 12' / 2 mm



Staff Level Ref.-No. 471 212

- Metal staff level
- Adjustable
- Sensitivity: 25'



Folding Levelling Rules Geomess

- Sections of white painted wood, length: 0.3 m or 0.5 m
- Durable brass hinges
- Front: levelling graduation
- Back: mm-graduation

Ref.-No.	Length	Length of sections	Weight
698 911	2 m	0.5 m	0.35 kg
699 011	3 m	0.5 m	0.53 kg
699 311	3 m	0.3 m	0.68 kg
699 111	4 m	0.5 m	0.77 kg

Self-Illuminating Levelling Staff LumiScale

LumiScale is a self-illuminating levelling staff for digital levels for use under unfavourable light conditions such as underground and tunnelling construction projects. With regard to its precision, self-illuminating levelling staff **LumiScale** fulfills the norm DIN 18703.

The **LumiScale** graduation is back-lit via an electroluminescent foil which uniformly illuminates the entire graduation without any shades. Extensive tests, performed by the University of Graz, Austria, have proven that measuring errors are eliminated thanks to the equable illumination of the graduation. For this reason the **LumiScale** technology is superior to an external illumination of the graduation. **LumiScale** is available with bar codes for all common digital levels.

Features:

- Illuminated graduation
- Illuminated bubble
- Supplied with rechargeable batteries, charger and bag

Nedo LumiScale

Bestell-Nr.	
Ref.-No. 340 220	LumiScale with Trimble bar code
Ref.-No. 340 222	LumiScale with Leica DNA bar code
Ref.-No. 340 224	LumiScale with Sokkia/Topcon bar code
Ref.-No. 340 225	LumiScale with Leica-Sprinter bar code

Technical data:	
Graduation	bar code
Carrier of graduation	polyester film ($\alpha_{TH} < 18 \text{ ppm}/^{\circ}\text{C}$)
Accuracy	$\Delta l = \pm(0.2 \text{ mm} + 2l \cdot 10^{-4})$
Illuminated area	2125 mm x 25 mm
Illumination	electroluminescent foil
Power supply	removeable NiMH rechargeable batteries, 2000 mAh
Operation duration	approx. 10 h
Circular bubble	illuminated, sensitivity 12'
Protection class	IP 54
Dimensions	2200 mm x 70 mm x 60.5 mm
Body of staff	aluminium profile
Weight	approx. 4.0 kg (with rechargeable batteries)



Overview EDM Accessories

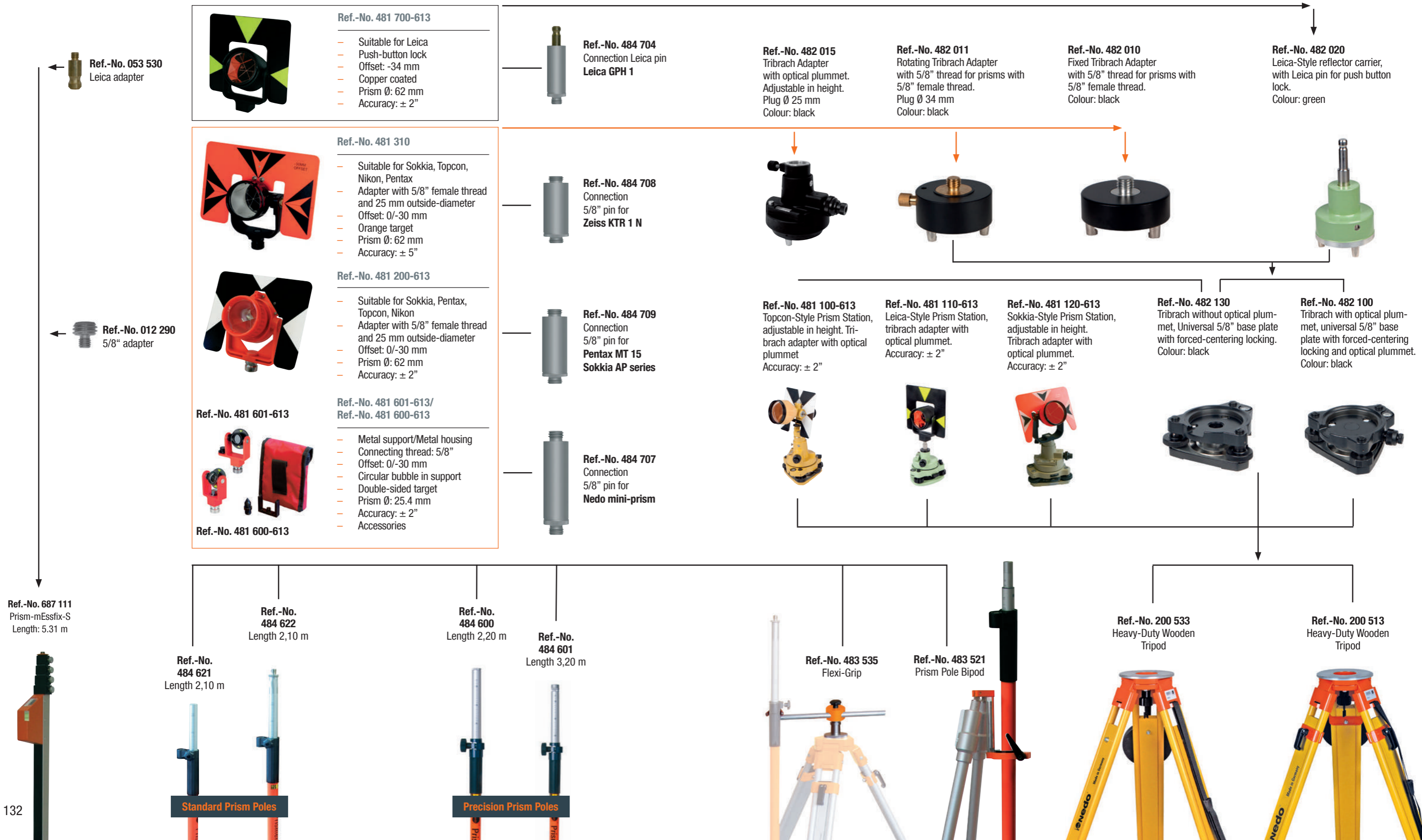

Ref.-No. 053 530
Leica adapter



Ref.-No. 481 700-613

- Suitable for Leica
- Push-button lock
- Offset: -34 mm
- Copper coated
- Prism Ø: 62 mm
- Accuracy: ± 2"

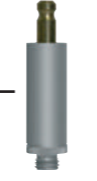

Ref.-No. 484 704
Connection Leica pin
Leica GPH 1

Ref.-No. 482 015
Tribrach Adapter
with optical plummet.
Adjustable in height.
Plug Ø 25 mm
Colour: black

Ref.-No. 482 011
Rotating Tribrach Adapter
with 5/8" thread for prisms with
5/8" female thread.
Plug Ø 34 mm
Colour: black

Ref.-No. 482 010
Fixed Tribrach Adapter
with 5/8" thread for prisms with
5/8" female thread.
Colour: black

Ref.-No. 482 020
Leica-Style reflector carrier,
with Leica pin for push button
lock.
Colour: green



Ref.-No. 481 310

- Suitable for Sokkia, Topcon, Nikon, Pentax
- Adapter with 5/8" female thread and 25 mm outside-diameter
- Offset: 0/-30 mm
- Orange target
- Prism Ø: 62 mm
- Accuracy: ± 5"



Ref.-No. 484 708
Connection
5/8" pin for
Zeiss KTR 1 N



Ref.-No. 481 100-613
Topcon-Style Prism Station,
adjustable in height. Tri-
brach adapter with optical
plummet
Accuracy: ± 2"

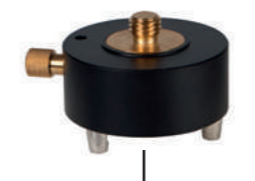

Ref.-No. 481 110-613
Leica-Style Prism Station,
tribrach adapter with
optical plummet.
Accuracy: ± 2"



Ref.-No. 481 120-613
Sokkia-Style Prism Station,
adjustable in height.
Tribrach adapter with
optical plummet.
Accuracy: ± 2"



Ref.-No. 482 130
Tribrach without optical plum-
met, Universal 5/8" base plate
with forced-centering locking.
Colour: black



Ref.-No. 482 100
Tribrach with optical plum-
met, universal 5/8" base
plate with forced-centering
locking and optical plummet.
Colour: black



Ref.-No. 481 200-613

- Suitable for Sokkia, Pentax, Topcon, Nikon
- Adapter with 5/8" female thread and 25 mm outside-diameter
- Offset: 0/-30 mm
- Prism Ø: 62 mm
- Accuracy: ± 2"



Ref.-No. 484 709
Connection
5/8" pin for
Pentax MT 15
Sokkia AP series

Ref.-No. 012 290
5/8" adapter



**Ref.-No. 481 601-613/
Ref.-No. 481 600-613**

- Metal support/Metal housing
- Connecting thread: 5/8"
- Offset: 0/-30 mm
- Circular bubble in support
- Double-sided target
- Prism Ø: 25.4 mm
- Accuracy: ± 2"
- Accessories



Ref.-No. 484 707
Connection
5/8" pin for
Nedo mini-prism

Ref.-No. 687 111
Prism-mEssfix-S
Length: 5.31 m



Ref.-No. 484 622
Length 2,10 m



Ref.-No. 484 621
Length 2,10 m

Standard Prism Poles

Ref.-No. 484 600
Length 2,20 m



Ref.-No. 484 601
Length 3,20 m

Precision Prism Poles



Ref.-No. 483 535
Flexi-Grip



Ref.-No. 483 521
Prism Pole Bipod



Ref.-No. 200 533
Heavy-Duty Wooden
Tripod



Ref.-No. 200 513
Heavy-Duty Wooden
Tripod

Ergonomic soft grip for convenient handling



Nedo Prism Poles

Standard Prism Poles made of Aluminium

Sturdy aluminium **prism poles** with screw clamp. Plastic handle with integrated adjustable circular bubble. The poles can be taken apart for cleaning without any tools.

With replaceable steel points.

Prism Pole Ref.-No. 484 621

- Standard model
- 5/8" connection thread

Prism Pole Ref.-No. 484 622

- With combi adapter M8 / 5/8"
- Suitable for Zeiss TR1N prism



Optionales Zubehör: Hülle



Nedo Prism Poles with Screw Clamp

Ref.-No.	Model	Working range	Transport length	Ø Outer tube/Ø Inne tube	Weight	Accessory case
484 621	Aluminium with 5/8" thread	125 cm - 210 cm	110 cm	32/25 mm	1.1 kg	494 112-613
484 622	Aluminium with combi adapter	125 cm - 210 cm	117 cm	32/25 mm	1.1 kg	494 113-613

Prism Poles

Precision Aluminium Prism Poles

The top line of Nedo **prism poles** features an innovative clamping system that provides greater ease of use, maximum precision and excellent straightness, even when the pole is fully extended.

The precision **prism poles** have a maximum length of 2.20 m. They can also be supplied with a 1 m extension that can be parked in the scale tube for transport. This increases the maximum length to 3.20 m.

Features:

- Excellent straightness even when fully extended
- Innovative clamping system
- Ergonomic soft grip for convenient handling
- Replaceable steel points
- Adjustable circular bubble with 20" accuracy
- 5/8" internal thread, compatible with all Nedo prism adapters



Excellent straightness even when fully extended

Nedo Precision Prism and GPS Poles

Ref.-No.	Model	Working range	Transport length	Ø Outer tube/Ø Inne tube	Weight	Accessory case
484 600	Aluminium with 5/8" thread	129 cm - 220 cm	114 cm	32/25 mm	1.18 kg	494 112-613
484 601	Aluminium with 5/8" thread and 1 m extension	129 cm - 320 cm	114 cm	32/25 mm	1.50 kg	494 112-613

Nedo Prism-mEssfix-S and Accessories for Prism Poles



Prism-mEssfix-S

Prism pole with analogue display. The built-in measuring tape displays the height of the centre of the prism in reference to the foot.

The extending sections are equipped with clamping screws, enabling each section to be locked in any position.

Working range: 1.53 m to 5.31 m.

The adapters for the most commonly used prisms are shown below.

Important: When placing your order, please state the exact type of prism you will use with the Prism-mEssfix-S and the connecting thread of your prism.

Ref.-No. 687 111



Prism Pole Bipod

Solid **prism pole bipod** with 2 telescopic legs. Height adjustable by means of a push-button.

Suitable for all Nedo aluminium prism poles.

Ref.-No. 483 521



Extension for Prism Pole

1 m extension, suitable for all Nedo prism poles.

5/8" connecting thread on both ends.

Ref.-No. 383 615



Bag for Prisms

Suitable for all prisms.

Ref.-No. 060 076



Prism Pole Accessories

Nedo Prism Pole Support Flexi-Grip



Upgrade your tripod with 5/8" thread. Simply attach **Flexi-Grip** to a tripod. When releasing the central clamping screw the support clamp can be moved three-dimensionally in any direction.

The prism pole is positioned on the target point and aligned with the bubble. **Flexi-Grip** follows every movement in any direction. Once the upright position is found the entire system is fixed by using the central clamping screw.

Very easy to handle.

With a tripod **Flexi-Grip** offers a secure stand and is therefore suitable for work in windy conditions.

Ref.-No. 483 535

Adapters to adjust the height of different prisms to the scale of all Nedo prism poles.

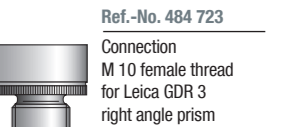
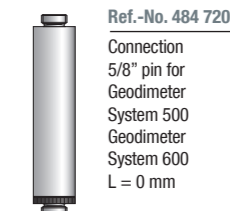
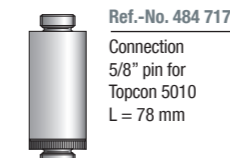
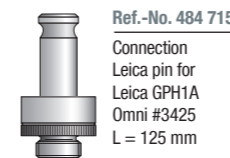
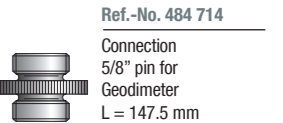
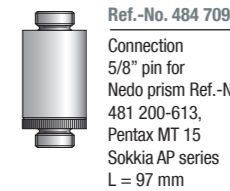
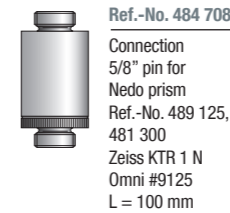
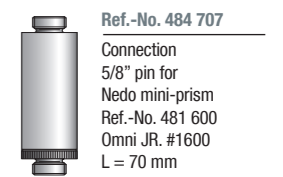
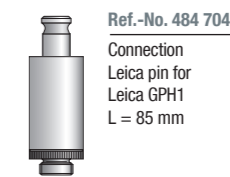
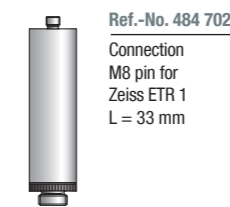
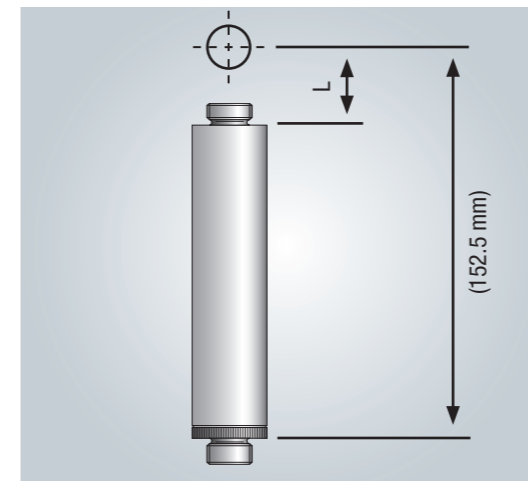

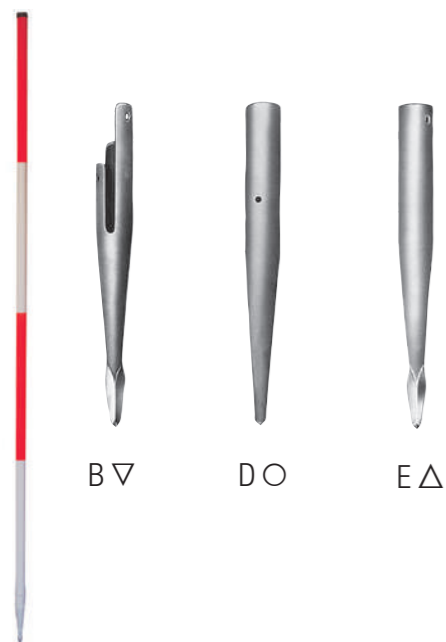

Ranging Poles

Wherever surveying and marking projects take place Nedo ranging poles are broadly used. Extremely robust points D are suitable for use on clay soil. Points B and E are perfect for use on sandy grounds.



Nedo Wooden Ranging Poles

All wooden ranging poles are made of knot-free, well-seasoned spruce wood and feature a high-density 0.5 mm PVC coating which protects them from corrosion.

Nedo Wooden Ranging Poles

Ref.-No.	No. of poles in package	Length incl. point	Pole Ø	Coating	Type of point
123 112	12	2.16 m	28 mm	PVC	B

Nedo Fibreglass Ranging Poles

Nedo fibreglass ranging poles stand out thanks to their high strength and exceptional straightness. They are virtually unbreakable, springing back to their original form - even after extreme demand.

Nedo Fibreglass Ranging Poles

Ref.-No.	No. of poles in package	Length incl. point	Pole Ø	Coating	Type of point
113 432	12	2.16 m	25 mm	-	E

Nedo Tubular Steel Ranging Poles

Nedo tubular steel ranging poles are made of high-grade steel and feature a high-density 0.5 mm PVC coating which protects them from corrosion. The tip is forged on.

Nedo Tubular Steel Ranging Poles

Ref.-No.	No. of poles in package	Length incl. point	Pole Ø	Coating	Type of point
127 511	12	2.16 m	25 mm	PVC	D

Nedo Construction Ranging Poles

Construction ranging poles made of steel are used especially for marking-out work on construction sites. Their diameter of 25 mm makes them extremely strong. The tip is forged on.

Nedo Ranging Poles

Ref.-No.	No. of poles in package	Length incl. point	Pole Ø	Coating	Type of point
122 515-616	16	2.00 m	25 mm	PVC	D

Sectional Nedo Ranging Poles

Sectional Steel Ranging Pole

Features:

- With a point on each metre element
- Pole Ø: 25 mm
- PVC coating: approx. 1 mm
- No. of poles in package: 6 pcs.



Ref.-No. 126 511-616



Ref.-No. 126 511-616



Ref.-No. 156 111

Ref.-No. 160 111

Nedo Canvas Bags for Sectional Ranging Poles

Nedo Canvas Bags for Sectional Ranging Poles

Ref.-No.	Suitable for
156 111	3 poles (6 sections) No. 126 511-616, 149 611
160 111	6 poles (6 sections) No. 126 511-616, 149 611

Nedo Ranging Pole Supports

Nedo **ranging pole supports** feature a robust design and high stability. Therefore, they can be used for ranging poles as well as for prism poles and GPS poles.



Nedo Heavy-Duty Ranging Pole Support

Features:

- Heavy-duty design
- Tripod legs with zinced telescope mechanism
- Orange powder-coated metal parts
- Ball joint head with support clamp
- Height: 0.71 m – 1.35 m
- Weight: 3.2 kg

Ref.-No. 177 212



Ranging Pole Support

Features:

- Lightweight design
- Orange powder-coated legs
- Ball joint head with support clamp
- Tripod legs locked by thumb screw
- Height: 1 m
- Weight: 1.6 kg
- No. of poles in package: 5 pcs.

Ref.-No. 177 111 (No. of poles in package: 5 pcs.)

Ref.-No. 177 111-616 (No. of poles in package: 1 pcs.)



Ranging Pole Support

Features:

- Lightweight design
- Identical to Ref.-No. 177 111, but without possibility of locking the legs
- Height: 1 m
- Weight: 1.6 kg

Ref.-No. 176 111 (No. of poles in package: 5 pcs.)

Ref.-No. 176 111-616 (No. of poles in package: 1 pcs.)

Surveying Accessories

Field Umbrella

The ideal protection against rain and sun. Supplied with three support ropes as a standard. Ground spike and carrying bag available as accessories.



Nedo Field Umbrellas

Ref.-No.	Ø
311 111	2.0 m

Accessories

Ref.-No.	
316 111	Ground spike
315 111	Carrying bag



Ground spike for field umbrellas



Carrying bag for field umbrellas



Nedo Field Bag

The practical canvas bag stores your measuring tape, calculator, field frame, optical square etc. Equipped with practical handle and shoulder strap. Additional pockets on the front for pens etc.

Ref.-No. 655 111

Nedo Field Frames

For notes and drawing on construction sites Nedo's **field frame** is indispensable. A robust aluminium plate serves as a writing pad. A thick transparent foil protects the drawings. Two metal lock knobs. Frame made of wood or plastics. Available in A4 or A3 size.

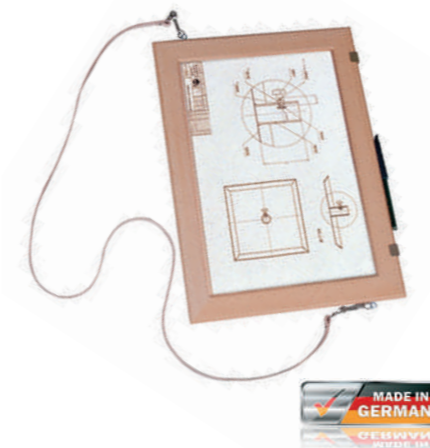

Nedo Field Frames

Ref.-No.	Version	Size	Weight
645 250	Wood	DIN A4	0.7 kg
645 242	Plastic	DIN A4	0.8 kg
645 245	Wood	DIN A3	1.1 kg
645 260	Plastic	DIN A3	1.4 kg

Surveying Accessories



Double Pentaprism with Wide Angle

Field of view: $\pm 45^\circ$. Mirrorcoated top and bottom surfaces of prisms. Extra large field of view and foresight viewing. With twist-off cap. Incl. case.

Ref.-No. 761 111



Optical Square

90° prism, weight 25 g. Supplied with case as a standard.

Ref.-No. 762 111



Perlon plumb line

1 roll of perlon plumb line, 100 m

Ref.-No. 785 111



Zinc Diecasting Plumb Bob

Polished steel. With removable brass head.

Order information:

- Ref.-No. 780 150 Weight 150 g
- Ref.-No. 780 200 Weight 200 g
- Ref.-No. 780 250 Weight 250 g
- Ref.-No. 780 300 Weight 300 g
- Ref.-No. 780 400 Weight 400 g
- Ref.-No. 780 500 Weight 500 g



Steel Plumb Bob

With removable brass head.

Order information:

- Ref.-No. 781 100 Weight 100 g
- Ref.-No. 781 150 Weight 150 g
- Ref.-No. 781 200 Weight 200 g



High-Visibility Vest

High-visibility vest for better safety where visibility is poor.

Ref.-No. 620 001

Sales and Supply Conditions

1. The following Supply Conditions apply to all contracts, deliveries and other performances, including advisory services, unless they have been amended or excluded with our expressed consent. Any General Terms and Conditions of Business of the customer/purchaser are not binding even if we have not again expressly rejected them.
2. The prices applicable on the delivery date shall be determinant.
3. Domestic deliveries under 500,- Euro net value of goods shall be shipped ex works. For domestic deliveries of 500,- Euro or more net value of goods, we will absorb the standard freight and postal charges. For deliveries to the EU countries FR, BE, LU, NL, DK, PL, CZ, AT, we assume the freight costs from a net value of goods of € 1,000. Deliveries to other EU countries are free of charge from a net goods value of € 2,000. Deliveries to third countries are ex works.
4. Consignments are made exclusive of packing. The packing on pallets and in crates is made available at prime cost..
5. **Quotation and conclusion of contract**
All our quotations are given without commitment. Contracts and other agreements shall become binding only by way of our written confirmation or delivery. If our sales staff or agents make oral agreements or provide assurances which go beyond the scope of our quotation, these shall always require our written confirmation in order to be valid. Unless otherwise agreed, documents forming part of the quotation, such as illustrations, drawings, particulars of weights and dimensions, are only approximate.
6. **Delivery conditions and defective performances**
If specific lead-times or delivery dates are not fulfilled, the customer wishing to withdraw from the contract or claim compensation or nonfulfillment shall not be released from the need to allow a suitable grace period for the performance and to issue a statement that he will refuse the performance after the expiry of the period. This shall not apply if we have expressly stated in writing that a lead-time or delivery date is binding. Reasonable partial consignments are permissible. Lead-times – even those established after a delay – shall be suitably extended in the event of force majeure and also unforeseen impediments occurring after the conclusion of the contract and for which we are not responsible, in so far as such impediments seriously affected delivery of the purchased item. We shall not be held responsible for delay in delivering and failure (impossibility) to deliver as long as the person we employ fulfill our obligations and our own suppliers attribute no fault to us. We shall not be held liable for delayed deliveries or failures (impossibility) to deliver for which our suppliers are to blame. The customer's right to withdraw, after a grace period allowed to us has expired without result, remains unimpaired.

7. **Shipment and transfer of risk**
Unless otherwise agreed, the route and mode of shipment are left at our discretion. At customer's request the goods shall be insured. The risk shall be transferred to the customer upon despatch. If shipment is delayed at the customer's request or for a reason attributable to it, the goods shall be stored at the customer's expense and risk. In such case, the notice that the goods are ready for despatch shall rank as despatch.
8. The goods are shipped ex-works at the recipient's risk. Any complaints concerning transport damage must be made upon receipt.
9. **Prices and payment**
Unless otherwise agreed, payment shall be remitted within 30 days from invoice date so that the sum agreed as settlement of the invoice is at our disposal not later than the due date. Only if an according agreement exists, a discount able, properly taxed bill of change shall be accepted for mode of payment. Cheques and drafts are credited under the premise of being honored, costs being deducted, and payment shall be considered duly received on the day the amount is actually at our disposal.
10. In the event of late payment, interest on defaulted payment is charged at 4% above the Main refinancing operations Minimum bid rate of the ECB, without a special reminder being required.

11. **Retention of title**
We retain the title of the goods until full payment of the purchase price. In the case of goods sold by the customer as part of its business activities, we retain the title until all claims upon the customer deriving from the business relationship have been settled. This shall apply even if some or all of the claims have been entered in a current account and the balance has been drawn up and acknowledged. If substantial contractual obligations are infringed and especially in the event of delayed payment, we may take back the goods after issuing a reminder and the customer shall be obliged to deliver them up. Unless the German Hire Purchase Law applies, our taking-back or imposition of attachment shall imply withdrawal from the contract only if we have expressly stated this in writing. In the event of attachment or other impairments of rights by third parties, the customer shall inform us in writing, sending a record of attachment and an affirmed and signed statement identifying the attached items. The customer may resell the goods in the normal course of business and he assigns to us hereby the claim deriving from the resale together with all ancillary claims which he acquires upon his customer or third parties as a consequence of the resale. The customer is authorised to collect the debt, even after the assignment. Our right to collect the debt ourselves remains unimpaired thereby but we undertake not to collect the debts as long as

the customer duly fulfills his payment obligations. them, to provide all information required to collect them, to deliver up the pertinent documents and advise the debtors of the assignment. We undertake to release the security held by us in as much as the value thereof exceeds the secured claims by more than 20 %, in so far as they may not yet have been settled.

12. **Liability for Defects and Warranty Claims**
Minor defects shall neither constitute a right on the Customer's part to refuse acceptance nor justify any warranty claims. We accept liability for defects subject to the following conditions:
 - (1) The delivery items in question found to be defective within the warranty period, provided that such defects can be established to have existed at the time of passage of risk, shall either be repaired or a substitute delivery shall be made free of charge respectively at our discretion.
 - (2) All warranty claims shall become statute-barred after 12 months. This shall not apply where the German laws pursuant to § 438 Para. 1 No. 2 (structures and objects for structures), § 479 Para. 1 (right of recourse) and § 634a Para. 1 No. 2 (building defects) of the German Civil Code (BGB) dictate longer periods of limitation, nor in the case of any loss of life, bodily injury or health impairment, in the case of any wilful or grossly negligent breach of duty on the part of the Supplier and in the event of fraudulent concealment of a defect. This shall not affect the statutory provisions concerning the suspension of expiration of prescription, suspension of the running or the re-running of the statute of limitation.
 - (3) Following the timely service of a notice of defects, we shall be granted the opportunity for subsequent performance within a reasonable period of time. Should such subsequent performance prove to be a failure, the Customer may – irrespective of his right to claim for damages pursuant to Para. 15) – rescind the Contract or effect a price reduction.
 - (4) We shall not accept warranty claims in the case of merely minor deviations from any warranted quality, in the case of any insignificant reduction in serviceability, in the case of natural wear and tear or any damage caused after the passage of risk to the Customer by incorrect or negligent handling, excessive use, unsuitable operating fuels or materials, or due to defective building works, unsuitable building sites or caused by external influences which were not been taken into account in the Contract, nor damage due to non-reproducible software faults. In the event that the Customer or any third party make any unauthorised changes or carry out any unauthorised repairs, we shall not accept liability for any such changes or repairs nor for any consequential faults.
 - (5) The Customer shall only have a right of recourse against us pursuant to § 478 of the German Civil Code (contractor's right of recourse) in so far as the Customer has made no agreements with his customers extending beyond the limits of the statutory warranty claims.
 - (6) In all other respects, Para. 15) hereunder shall apply to the Customer's right to claim for damages. All other claims by the Customer against us and our vicarious agents or claims other than those covered by this section shall be excluded.
13. We reserve the right to deviate from the illustrations in the catalogue in order to enhance our products.
14. **Impossibility, Adaptation of Contract**
 - (1) To the extent that a delivery is deemed impossible, the Customer shall have the right to claim for damages, unless such impossibility is beyond our control. However, any claim for damages by the Customer shall be limited to 10 % of the value of such part of the delivery item which could not be put into expedient operation as a result of the impossibility. This limitation shall not apply in case of any mandatory liability as in the case of wilful intent and gross negligence or in the case of any loss of life, bodily injury or health impairment. This is not associated with any changes to the burden of proof to the detriment of the Customer and shall not affect the Customer's right to rescission.
 - (2) In the event of any unforeseeable events, such as mobilisation, war, riot or any other similar events, such as strike action and lock-out, should substantially change the economic value or the contents of the delivery item or should such events have a considerable impact on our business operations, the Contract shall be appropriately adapted, bearing in mind the requirements of good faith. If this is not practicable for economic reasons, we shall have the right to withdraw from the Contract..
15. **Other Claims for Damages**
 - (1) All other claims for damages or compensation claims on the part of the Customer (hereinafter: claims for damages), irrespective of the legal grounds on which they may be based, in particular, claims based on any breach of duty arising out of the relationship under the law of obligations and any tortious acts, shall be excluded.
 - (2) This shall not apply in the case of any mandatory liability, for example under the Product Liability Act, in the event of wilful intent or gross negligence, in the case of any loss of life, bodily injury or health impairment or in the case any breach of an essential contractual duties. Any claim for damages based on a breach of an essential contractual duty, however, shall be limited to foreseeable damage or losses as are typical for contracts such as the one between the Contracting Parties, except in the event of wilful intent or gross negligence or in the case of mandatory liability following a loss of life, bodily injury or health impairment. This is not associated with any changes to the burden of proof to the detriment of the Customer.
 - (3) To the extent that the Customer is entitled to claim for damages pursuant to this section 15), all such claims shall become statute-barred upon expiration of the statute of limitation applicable to warranty claims pursuant to Para. 14) above.
 - (4) Damage claims under the Product Liability Act shall be subject to the statutory limitation rules.
16. **Place of Performance, Jurisdiction, Applicable Law**
The place of performance and exclusive place of jurisdiction for all deliveries and payments (incl. legal action based on dishonoured cheques or bills of exchange), as well as all disputes arising between the Parties shall be Dornstetten, Germany, in so far as the Customer is a registered trader, a legal entity under public-law or a state-operated special fund. All contractual relations between the Contracting Parties shall be governed solely by the laws of the Federal Republic of Germany, excluding the Hague Convention relating to the Uniform Law on the International Sale of Goods.



Order informations Nedo „Tegometall“ Wall



Nedo POS-System - Optimum Product Presentation

The new Nedo POS system will help you to present Nedo products more successfully at the point of sale.

Why? Because your customers will find a visually attractive product presentation where exciting Nedo products are displayed in a compact area and can be tried and tested right at the point of sale.

Our product information card system will help both the dealer and the end user to understand and use our products very quickly.

On top of that, our display system generates cross-selling effects, and this means more sales.

Why? Once the customer has stopped in front of the display and is interested in one product, you have a direct opportunity right there to arouse his interest in additional Nedo products.

Nedo offers three different standard modules to present our best-selling items:

- All-purpose display panel (1m)
- Laser display panel (1m)
- Combination display panel (2m)

In addition, your Nedo sales consultant will be happy to help you put together your own display, tailored to your customers' needs and with the required products.

Generate more sales with the Nedo POS system!



Showcase

- Showcase, lockable
- Length: 100 cm

Ref.-No. 061 850



Product information cards

- Technical data of the products



Nedo Logo

- Nedo Logo Display
- Length: 100 cm
- Height: 40 cm

Ref.-No. 061 846



Rack for brochures

- Rack for brochures DIN A5 for Nedo Highlight brochures

Ref.-No. 061 855
(Without brochures)



Laser rack

- Mounting angle incl. screws

Ref.-No. 060 534



Laser rack for LINUS 1 HV and TUBUS 2

- Laser rack for universal laser LINUS 1 HV and Pipe laser TUBUS 2 incl. addapter.

Ref.-No. 062 808



Tripod mounting

- Tripod mounting with 5/8" thread

Ref.-No. 061 745-501



Hook D3

- Ø: 4 mm
- Depth: 20 cm

Ref.-No. 060 439



Double hook for measuring tools

- Double hook with price tag

Ref.-No. 059 998



Double hook with price tag

- Ø: 7 mm
- Depth: 30 cm

Ref.-No. 063 102



Raceway panel

- Length: 100 cm
- Height: 16 cm

Ref.-No. 061 840-500



Head signage holder centre piece

- Height: 40 cm

Ref.-No. 061 859-500



Footboard

- Height: 16 cm
- Depth: 47 cm

Ref.-No. 061 841-500



Head signage holder

- Height: 40 cm
- Set, right and left

Ref.-No. 061 847-500



Column 6x3

- Double sided
- Height: 240 cm

Ref.-No. 061 839-500

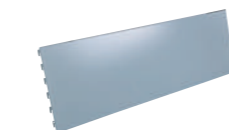

Back board GL 40

- Length: 100 cm
- Height: 40 cm

Ref.-No. 061 842-540

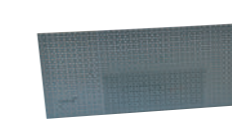

Hole back board RL

- Length: 100 cm
- Height: 40 cm

Ref.-No. 061 843-540



Back board GL 30

- Length: 100 cm
- Height: 30 cm

Ref.-No. 061 844-540



Lower shelf, orange

- Length: 100 cm
- Depth: 47 cm

Ref.-No. 061 845-500



Anti-slip mat

- Length: 33 cm
- Width: 23.5 cm

Ref.-No. 061 861



Screw

- Thread-rolling screw M6x20
- 1 piece

Ref.-No. 012 571

Nedo Corporate Headquarters

Nedo GmbH & Co. KG

Hochgerichtstrasse 39-43
D-72280 Dornstetten
Phone: +49/7443/2401-0
Fax: +49/7443/2401-45
Email: info@nedo.com

International Sales Network

Austria

Christian Pfau

Phone: +49 172 7269319
Fax: +49 7443 2401277
Email: pfau@nedo.com

Belgium/ Luxembourg

Prof Praxis NV/SA

Scheibeekstraat 29
BE-1540 Herne
Phone: +32 2 3563752
Fax: +32 2 3562178
Email: sales@prof-praxis.com

Denmark

Tajima Trading ApS

Aalborgvej 62A
DK-9560 Hadsund
Phone: +45 9652 0860
Fax: +45 9652 0861
Email : info@tajima.dk

France

Dominique SAUTET

30 Rue Churchill Roosevelt
FR-33350 Sainte Terre
Phone:+33 6 80 93 58 18
Fax:+33 8 21 16 88 95
Email: dsvmbat@gmail.com

Italy

TECHNOLASER Snc

Via Cervese 401
IT-47521 Cesena (FC)
Phone:+39 5 47 48 09 07
Fax:+39 5 47 48 09 07
Email: info@technolaser.it

Netherlands

MEMO B.V.

Maaskade 20
NL-5347 KD Oss
Phone: +31 412 632 032
Fax: +31 412 625 658
Email: info@memo-oss.nl

Norway

Maskinstyring AS

avd. Laserbutikken
Vognvegen 23
NO - 2072 Dal
Phone: +47 48 24 55 55
Email: post@maskinstyring.com

South America

Agente COHIGE S.L.

Calle Cala Puntal W
23 Puerta 19
12500 Vinaròs (Castellón)
Phone: +34 639 626 800
Fax: +34 925 395 165
Email: blanco@nedo.com

Spain

Agente COHIGE S.L.

Calle Cala Puntal W
23 Puerta 19
12500 Vinaròs (Castellón)
Phone: +34 639 626 800
Fax: +34 925 395 165
Email: blanco@nedo.com

Sweden

Alesto AB

Gjuterigatan 6
SE-34131 LJUNGBY
Phone: +46 831 5400
Email: info@alesto.se

Switzerland

Fimex Messgerätebau AG

Hauptstrasse 5
CH-8259 Kaltenbach
Phone: +41 52 7420020
Fax: +41 52 7420029
Email: info@fimexag.com

USA / Canada

Nedo

2200 Ampere Drive
P. O. Box 99556
Louisville, KY 40269-0556
Phone: 866-275-6336 (toll free)
Fax: 502-266-5280
Email: sales@usa.nedo.com



Precise surveying and measuring

Nedo GmbH & Co. KG

Hochgerichtstrasse 39-43
D-72280 Dornstetten

Phone +49 (0) 7443 24 01-0
Fax +49 (0) 7443 24 01-45

info@nedo.com
www.nedo.com